

# CUSTOM MADE





## CUSTOM MADE

In addition to delivering innovative and durable cooling solutions with a long service life, Greencooler proudly introduces the Custom-Made concept range of refrigerated beverage cabinets. These avant-garde solutions not only enhance your living spaces but also serve as advertising platforms to showcase your brand's corporate identity. We offer branding options tailored to your specific needs.

Greencooler, yenilikçi ve dayanıklı soğutma çözümleri sunmanın yanı sıra uzun ömürlü ürünler sağlayarak gururla özel tasarım soğutmalı içecek dolapları konseptini tanıtmaktadır. Bu ileri teknoloji çözümler, yaşam alanlarınızı güzelleştirmenin yanı sıra, markanızın kurumsal kimliğini sergilemek için reklam platformları olarak da hizmet vermektedir. Özel ihtiyaçlarınıza uygun markalama seçenekleri sunmaktayız.

YOUR  
DESIGN

YOUR  
PRODUCT

# GEOGRAPHIC DISTRIBUTION



CONNECT WITH THE WORLD.

# R&D Centre Ar-Ge Merkezi

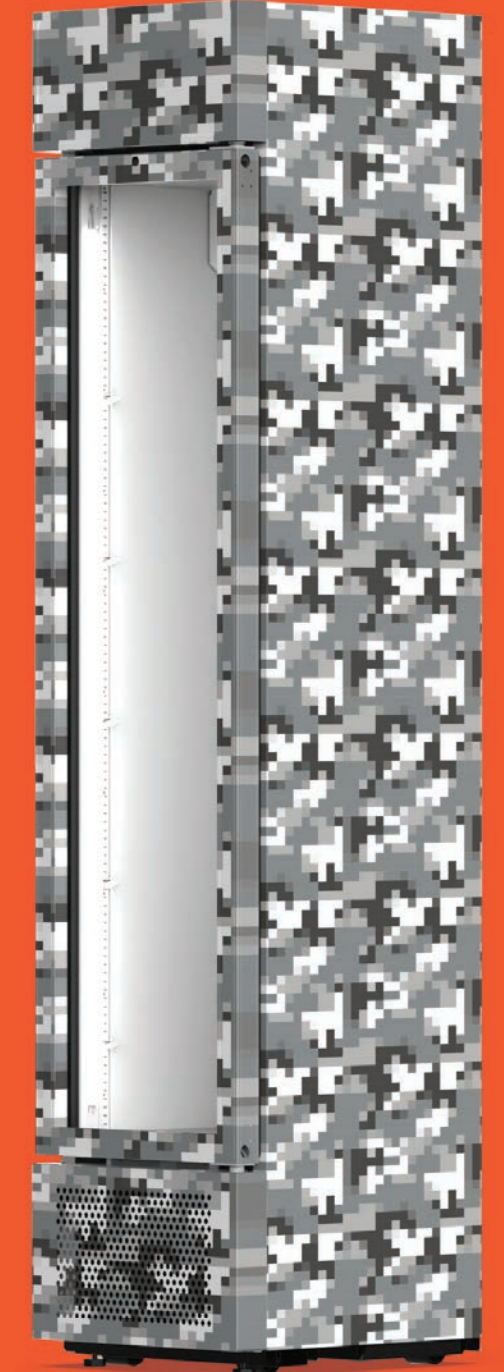



# WORLD COLLECTION

Tailored brand solutions for every space.

Our refrigerated beverage cabinets feature captivating lighting and designs ideal for bars, restaurants and similar venues.

Enhance your brand value with 3D logos on the canopy, door handles and grilles.

Her mekan için özel marka çözümleri.

Soğutmalı içecek dolaplarımız, barlar, restoranlar ve benzeri mekanlar için ideal olan etkileyici aydınlatma ve tasarımlara sahiptir.

Marka değerinizi, kanopi, kapı kolları ve ızgaralar üzerindeki 3D logolarla artırın.

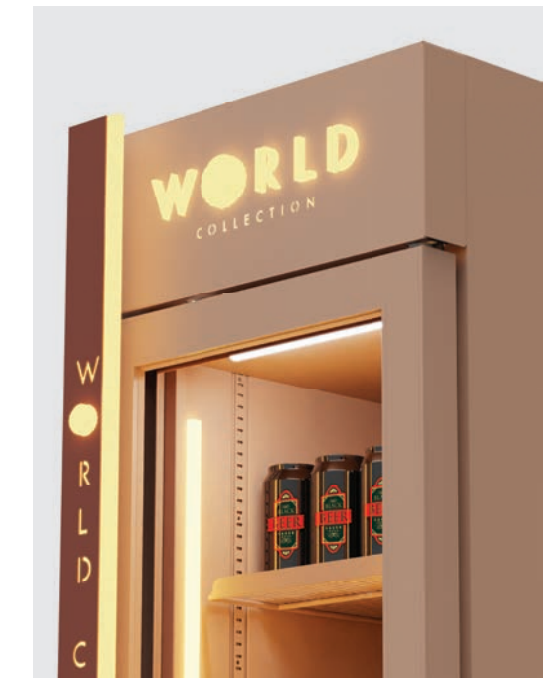

## MR

Elegance and optimal cooling united.

MR series seamlessly enhances the aesthetics of your products and spaces, perfectly complementing the details on your wine bottles.

It sets itself apart with customizable cladding and lighting options that align with your brand identity.

Zarafet ve optimal soğutma bir arada.

MR serisi, ürünlerinizin ve mekanlarınızın estetiğini kusursuz bir şekilde geliştirir, şarap şişelerinizin detaylarını mükemmel bir şekilde tamamlar.

Marka kimliğinizle uyumlu özelleştirilebilir kaplama ve aydınlatma seçenekleriyle öne çıkar.

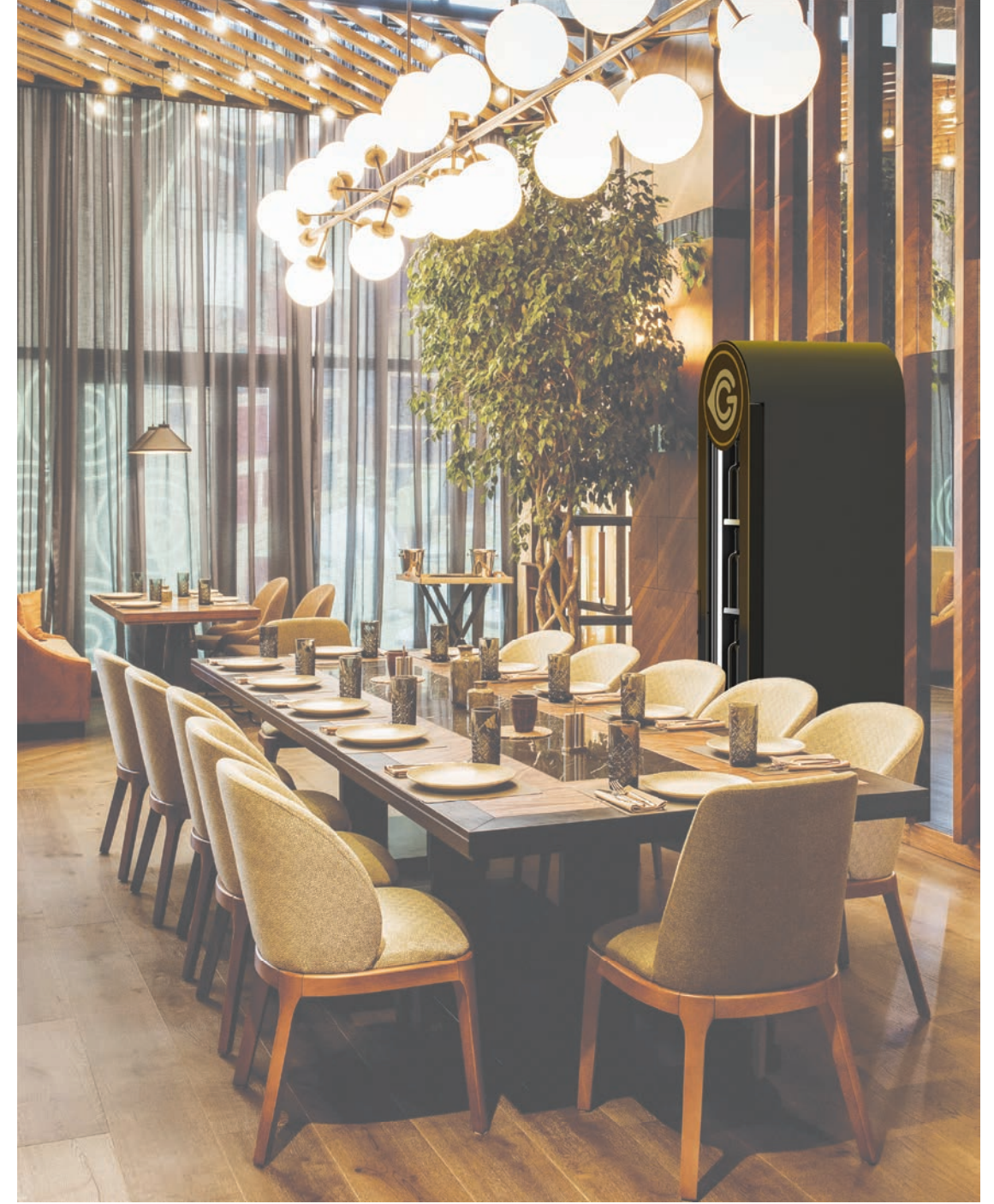

Leaflet



# NATURE

Unprecedented natural elegance and appeal.

Natural elements seamlessly blend in, offering both aesthetics and functionality with wood grain patterns, along with brand-specific customization options such as shelf quantity, color choices and lighting to enhance the overall look and functionality.

Eşi benzeri görülmemiş doğal zarafet ve çekicilik.

Doğal unsurlar kusursuz bir şekilde harmanlanarak, ahşap desenleri ile estetik ve işlevsellik sunar. Raf sayısı, renk seçenekleri ve aydınlatma gibi markaya özel özelleştirme seçenekleriyle genel görünüm ve işlevselliği artırır.



Leaflet





## RAIN

As powerful as rain.

Inspired by the beauty of rain, our Rain series elegantly showcases a single brand's diverse product range across various shelves, utilizing eye-catching color transitions to boost sales.

Designed for flexibility, Rain allows for customized designs tailored to your brand's corporate identity and campaign requirements, down to the way light falls on the door.

Yağmur kadar güçlü.

Yağmurun güzelliğinden ilham alan Rain serimiz, göz alıcı renk geçişleri kullanarak çeşitli raflarda tek bir markanın geniş ürün yelpazesini zarif bir şekilde sergiler ve satışları artırır.

Esneklik için tasarlanan Rain, markanızın kurumsal kimliği ve kampanya gereksinimlerine göre özelleştirilebilir tasarımlar sunar, ışığın kapıya düşme şekline kadar.



Leaflet

CUSTOM MADE

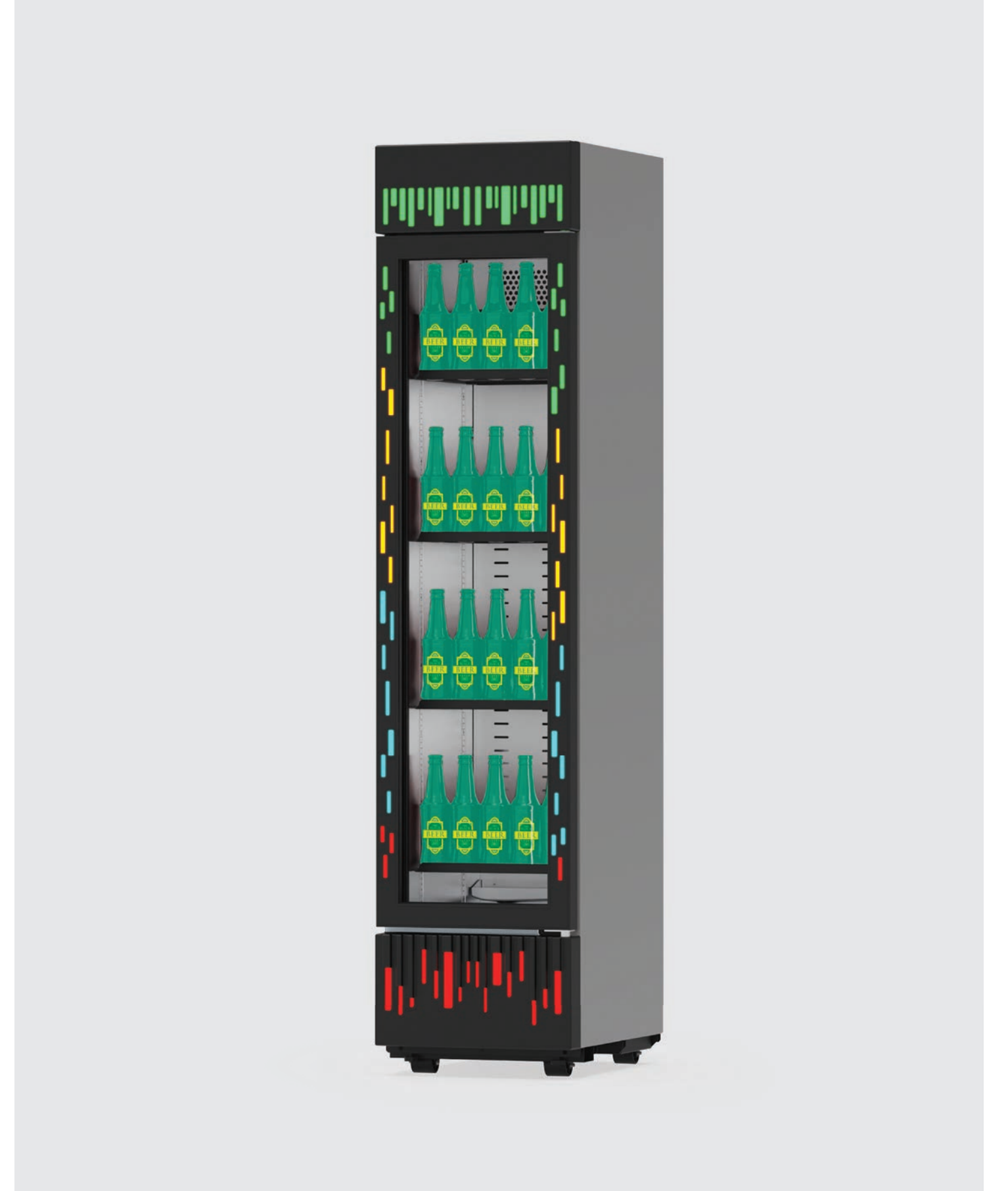

CUSTOM MADE



## BELT

Whatever you're looking for in a cooler, Belt has it.

Belt adds style with its angled area that can change shape and colour while increasing brand awareness by branding all its areas specific to your needs starting with the grille door.

Bir soğutucudan ne arıyorsanız, Belt'te var.

Belt, şekil ve renk değiştirebilen açılı alanıyla stil katar ve ızgara kapısından başlayarak tüm alanları ihtiyaçlarınıza göre markalayarak marka bilinirliğini artırır.



Leaflet





CUSTOM MADE



CUSTOM MADE

## COMBI

The ideal fusion of functionality and style.

Meet your expert cooler, Combi, designed to operate at two different temperatures simultaneously, keeping chilled consumer goods in the lower compartment and ready-to-drink beverages in the upper section. It can also maintain above-zero temperatures when needed.

Neon lighting in the door handles and custom detailing not only adds aesthetic appeal but also enhances brand recognition. Customizable with a variety of colors and lighting options to meet your specific requirements.

İşlevsellik ve tarzın mükemmel birleşimi.

İki farklı sıcaklıkta çalışmak üzere tasarlanan uzman soğutucunuz Combi ile tanışın. Alt bölümde soğutulmuş tüketim mallarını, üst bölümde ise içime hazır içecekleri saklayarak ihtiyaca göre sıfırın üstünde sıcaklıkları da muhafaza edebilir.

Kapı kollarındaki neon aydınlatma ve özel detaylar, estetik çekiciliğin yanı sıra marka tanınırlığını da artırır. Özel gereksinimlerinizi karşılamak için çeşitli renk ve aydınlatma seçenekleriyle özelleştirilebilir.



Leaflet



## CARBON

Seeking more than just a cooler?

Carbon can project your brand's visual identity to boost brand awareness and visibility.

Carbon captures the consumer's attention with unique lighting options, starting with neon lighting in the door handle, all while enhancing the aesthetic appeal.

Sadece bir soğutucudan fazlasını mı arıyorsunuz?

Carbon, markanızın görsel kimliğini yansıtarak marka bilinirliği ve görünürlüğünü artırabilir.

Kapı kolundaki neon aydınlatma ile başlayarak, benzersiz aydınlatma seçenekleriyle tüketicinin dikkatini çeker ve estetik çekiciliği artırır.



Leaflet



## BEAM

Want to make a striking impression even in the dark? Specially designed lighting that replicates the ripples caused by a drop of water on the grille and door adds a flawless aesthetic touch to your space.

Its lighting is sure to captivate everyone's attention in dark or dimly lit areas.

Karanlıkta bile dikkat çekici bir izlenim mi yaratmak istiyorsunuz?

Özellikle tasarlanmış aydınlatma, ızgarada ve kapıda bir damla suyun oluşturduğu dalgalanmaları taklit ederek mekanınıza kusursuz bir estetik dokunuş ekler.

Bu aydınlatma, karanlık veya loş alanlarda bile herkesin dikkatini çekecektir.



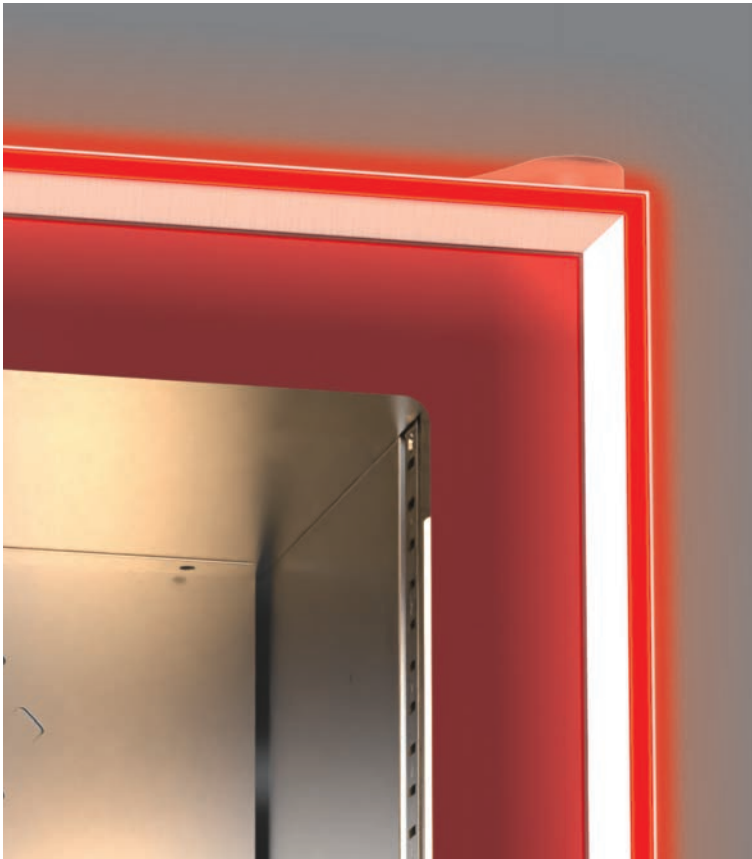

BETA SERIES



Leaflet





# ALFA SERIES



Leaflet

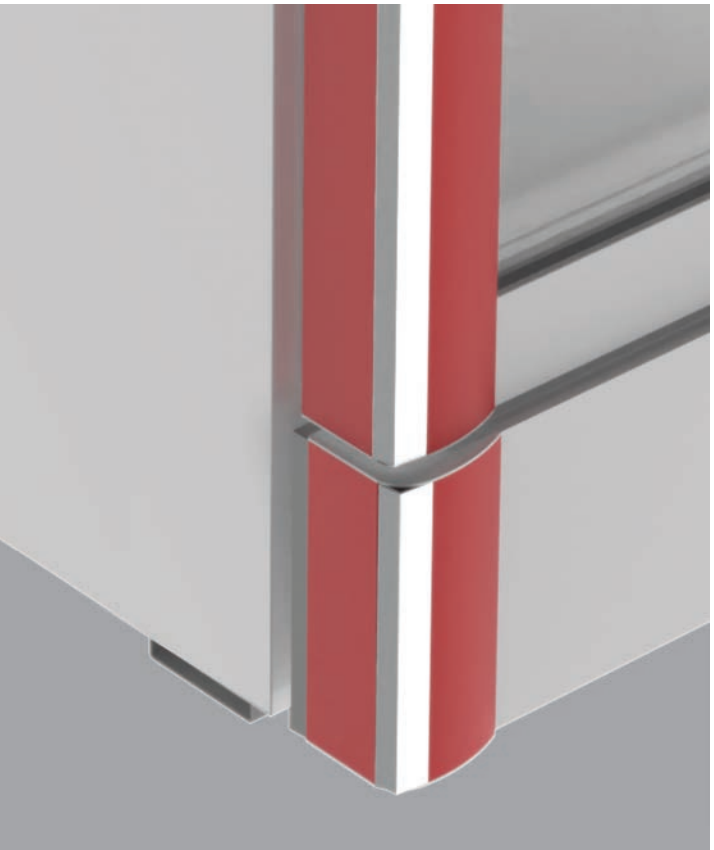



## STARFACE

It's impossible to overlook.

Starface, with its sculpted design, sharp lines and concealed LED lighting, imparts a distinctive touch to your architectural space and elevates brand recognition through customized glass doors and lighting options.

Görmezden gelmek imkansız.

Starface, şekillendirilmiş tasarımı, keskin hatları ve gizlenmiş LED aydınlatması ile mimari mekanınıza karakteristik bir dokunuş kazandırır ve özelleştirilmiş cam kapılar ve aydınlatma seçenekleriyle marka tanınırlığını artırır.



Leaflet





# REDROY

Retro design, modern solution!

Inspired by vintage jukeboxes, Redroy offers a variety of color and plastic part choices, ensuring its seamless integration into any space. It can be tailored to suit various brands and requirements, all while its chic Retro styling enhances brand visibility and complements the overall decor of its surroundings.

Retro tasarım, modern çözüm!

Vintage jukeboxlardan ilham alarak, Redroy çeşitli renk ve plastik parça seçenekleri sunar ve böylece herhangi bir mekâna sorunsuz bir şekilde entegre olur. Farklı markalar ve gereksinimlere uygun şekilde özelleştirilebilir ve şık Retro tarzıyla marka görünürlüğünü artırır, çevresinin genel dekorunu tamamlar.

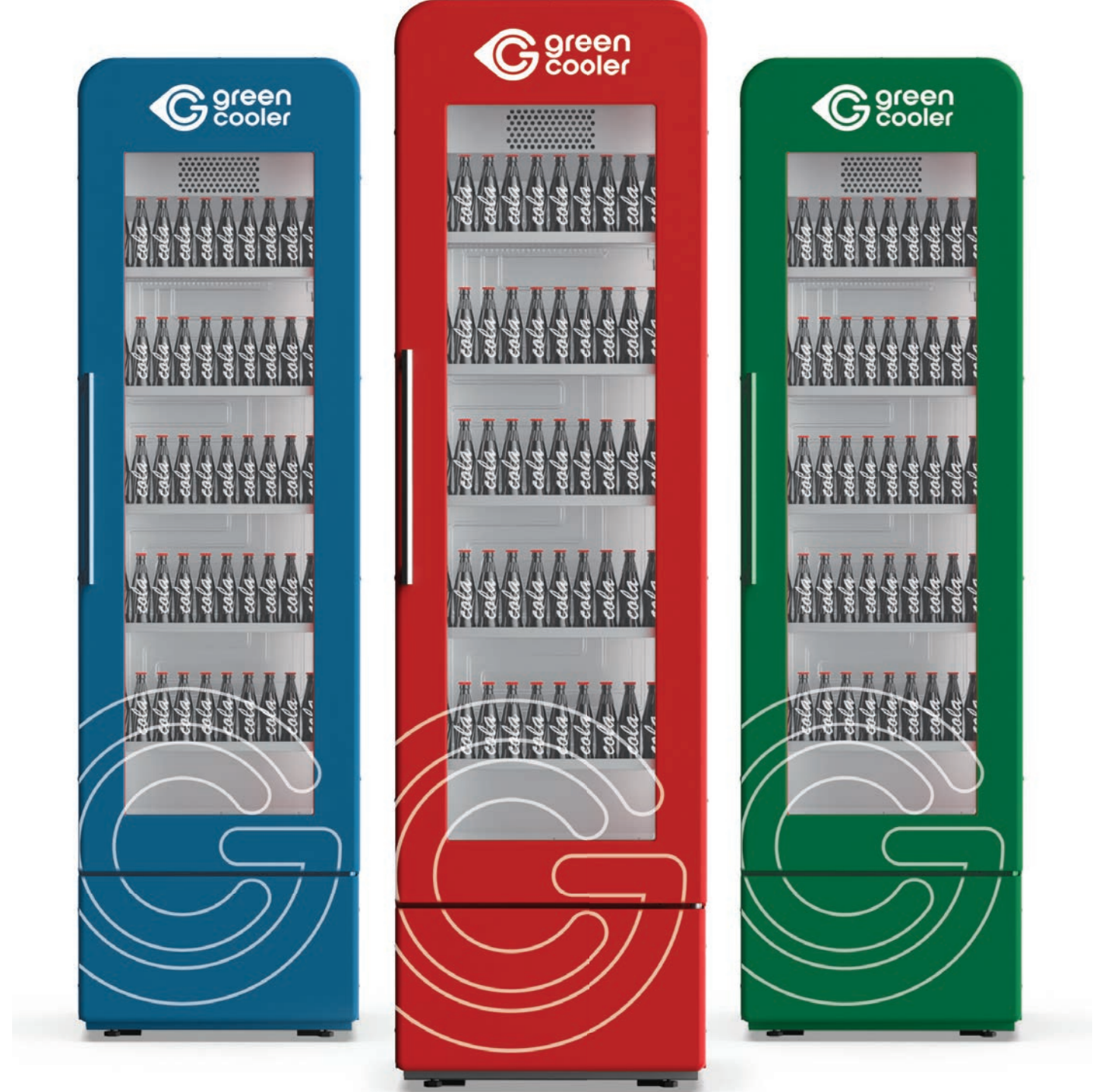

Leaflet

## BURN

It possesses all the qualities you would anticipate in a cooler and even more. But there's more to it than that.

Its distinctive lighting not only infuses style into spaces but also captivates attention.

With ample space on the grille to display a brand's logo and slogan, Burn allows you to convey all the visual messages necessary to impact the consumer's decision-making.

Bir soğutucuda beklediğiniz tüm özelliklere sahip ve hatta daha fazlasına. Ama bunun ötesinde.

Özgün aydınlatması sadece mekanlara stil katmakla kalmaz, aynı zamanda dikkatleri de üzerine çeker.

Gril üzerinde bir markanın logosunu ve sloganını sergilemek için yeterli alan sunan Burn, tüketicinin karar verme sürecini etkilemek için gerekli olan tüm görsel mesajları iletebilmenizi sağlar.

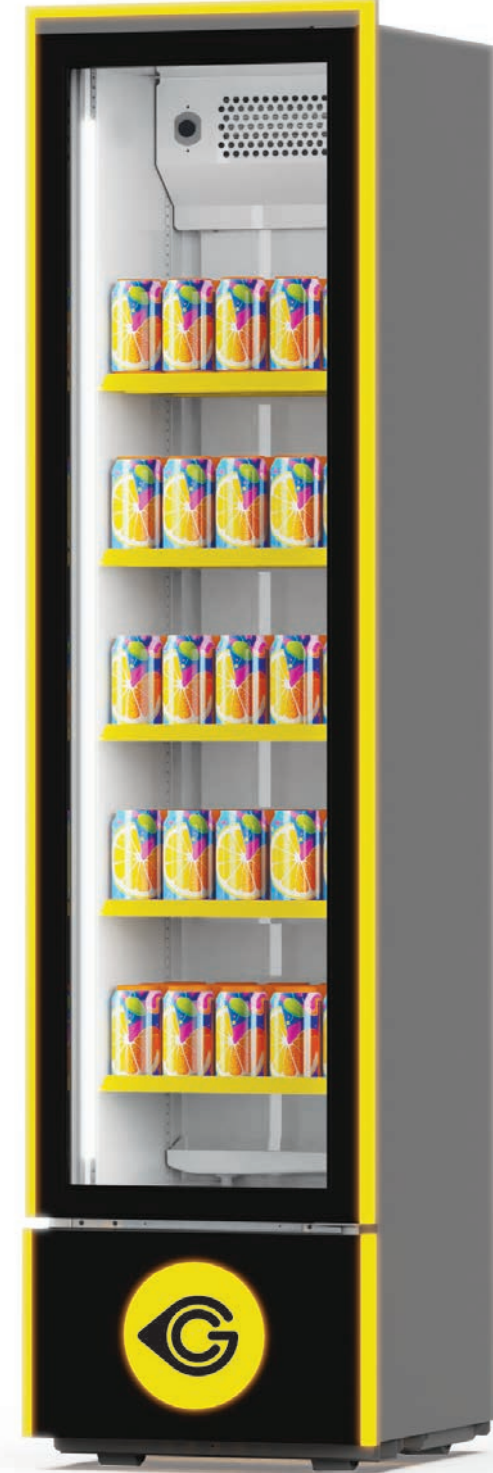



## DIAMOND

Brands and spaces will shine like diamonds!

Its distinctive design featuring diffracted lines and perfect lighting provides products with a stylish showcase. It contributes more to the ambiance of the location than merely being a cooler.

With brand-specific coloring and branding, it delivers not only flawless cooling but also an impeccable presentation.

Markalar ve mekanlar elmas gibi parlayacak!

Farklılaşan çizgiler ve mükemmel aydınlatmasıyla öne çıkan özgün tasarımı, ürünlere şık bir sergi alanı sunar. Sadece bir soğutucu olmaktan öte, mekanın atmosferine daha fazla katkı sağlar.

Marka özel renklendirme ve markalama ile sadece kusursuz soğutma sağlamakla kalmaz, aynı zamanda kusursuz bir sunum sunar.





CUSTOM MADE

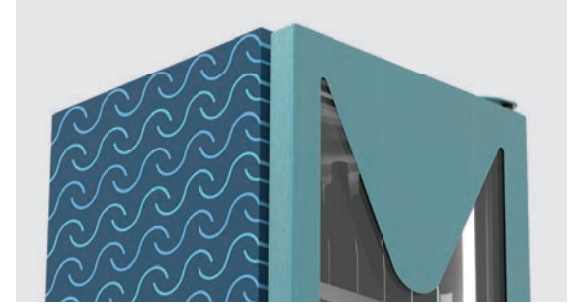

CUSTOM MADE

## DROP

Elegance born from simplicity.

Its fully glazed closed grille design allows you to place all the visual messages that will impact consumer decision-making, including the brand logo and slogan, to ensure they capture attention.

Basitlikten doğan zarafet.

Tamamen cam kapalı ızgara tasarımı, tüketicinin karar verme sürecini etkileyecek tüm görsel mesajları, marka logosu ve sloganı dahil olmak üzere dikkat çekmesini sağlamak için yerleştirmenize olanak tanır.



Leaflet

39



# PACIFIC

An Ocean Breeze

Inspired by the waves and breezes of the ocean, Pacific infuses style into your spaces while distinguishing you from others with its custom-designed cladding and lighting that aligns seamlessly with your brand identity.

Bir Deniz Esintisi

Deniz dalgalarından ve esintilerinden ilham alan Pacific, özel tasarım kaplama ve marka kimliğinizle mükemmel uyum sağlayan aydınlatmasıyla mekanlarınıza stil katarken sizi diğerlerinden ayırır.





# TUNA

Inspiration from the sea.

Drawing inspiration from the fast and sleek tuna fish, Tuna incorporates numerous advantages into its design. It prominently showcases advertising space through detailed grille and canopy designs, emphasizing brand awareness.

When you place the Left and Right Tuna models side by side, the result is an architectural design that introduces a touch of originality to any space.

Denizden ilham alarak.

Hızlı ve çevik ton balığından ilham alarak, Tuna tasarımına birçok avantaj ekler. Detaylı ızgara ve kanopi tasarımlarıyla reklam alanını ön plana çıkararak marka bilinirliğini vurgular. Sol ve Sağ Tuna modellerini yan yana yerleştirdiğinizde, herhangi bir mekâna özgünlük katacak mimari bir tasarım ortaya çıkar.



Leaflet

CUSTOM MADE



CUSTOM MADE



Leaflet

CUSTOM MADE



## ENIGMA

This cooler has a message to give!

Enigma is a cooler where each element on the grille is crafted to resemble a finely detailed code.

The seam between the door and grille remains discreet from the sides, creating a seamless, enigmatic ambiance in spaces, while providing perfect placement for products.

It stands apart with its polyurethane thickness and high energy efficiency.

Bu soğutucunun vermek istediği bir mesaj var!

Enigma, ızgaradaki her öğenin ince detaylı bir kodu taklit etmek üzere tasarlandığı bir soğutucudur.

Kapı ve ızgara arasındaki dikişler yan taraflardan gizli kalarak, mekanlarda sorunsuz ve gizemli bir atmosfer yaratırken ürünler için mükemmel bir yer sağlar.

Poliüretan kalınlığı ve yüksek enerji verimliliği ile dikkat çeker.





## LITA

The distinctive patterns on the grille and door, the captivating lighting, and the brand-specific cladding options are sure to captivate the consumer's attention.

Its seamless, unified, canopy-free design takes brand awareness to the next level by creating advertising space on the inside when the door is opened.

Designed with custom lighting and cladding options.

Gril ve kapıdaki benzersiz desenler, etkileyici aydınlatma ve markaya özel kaplama seçenekleri tüketicinin dikkatini çekmek için tasarlanmıştır. Kapısı açıldığında iç kısımda reklam alanı oluşturan, birbirine geçişli, tavana sahip olmayan tasarım marka bilinirliğini bir üst seviyeye taşır. Özel aydınlatma ve kaplama seçenekleri ile tasarlanmıştır.



Leaflet

CUSTOM MADE



CUSTOM MADE





## SOFT

Personalized cooling and custom detailing.

Soft, with its all-glass profile design, adds depth to both the space and product display area. It's designed to provide a wide range of color and lighting options to suit your preferences, emphasizing brand identity through its intricate detailing.

The specially designed door opens with a single touch of the handle, delivering an unmatched sense of comfort and luxury.

Kişiselleştirilmiş soğutma ve özel detaylar.

Tüm cam profilli tasarımıyla Soft, hem mekana hem de ürün sergi alanına derinlik kazandırır. Tercihlerinize uygun geniş renk ve aydınlatma seçenekleri sunmak üzere tasarlanmıştır ve karmaşık detaylarıyla marka kimliğini vurgular.

Özel olarak tasarlanmış kapı, kolu tek dokunuşla açarak eşsiz bir konfor ve lüks hissi sunar.



Leaflet





## MOUNTAIN

Designed for those seeking the pinnacle of coolers.

Inspired by the design of Mt. Everest, the world's tallest mountain, this model mirrors Everest's frigid and ever-challenging characteristics. Beyond exceptional cooling, it provides various plating designs, color combinations, and lighting options to align with your requirements, simultaneously making a unique contribution to spaces and brand recognition.

En üst düzey soğutucu arayanlar için tasarlandı. Dünyanın en yüksek dağı olan Everest'in tasarımından ilham alan bu model, Everest'in soğuk ve her zaman zorlayıcı özelliklerini yansıtıyor. Olağanüstü soğutmanın ötesinde, ihtiyaçlarınıza uygun çeşitli kaplama tasarımları, renk kombinasyonları ve aydınlatma seçenekleri sunar, aynı zamanda mekanlara ve marka tanınabilirliğine benzersiz bir katkı yapar.



Leaflet





## STEEL

Perfect, sharp lines.

Steel is the ideal cooler for those aiming to express their brand's visibility with sharp lines; a perfect example of enduring durability and robustness promised by Greencooler in each product.

It will proudly showcase your brand, even in the dimmest areas, thanks to its stainless steel body, raised logo option, and customizable lighting.

Mükemmel, keskin hatlar.

Steel, markanızın görünürlüğünü keskin hatlarla ifade etmeyi hedefleyenler için ideal bir soğutucudur; Greencooler'in her üründe vaat ettiği uzun süreli dayanıklılık ve sağlamlığın mükemmel bir örneğidir.

Paslanmaz çelik gövdesi, yükseltilmiş logo seçeneği ve özelleştirilebilir aydınlatması sayesinde en karanlık alanlarda bile markanızı gururla sergileyecektir.



Leaflet

CUSTOM MADE



CUSTOM MADE



## WOODEN

Unmatched natural elegance and coolness.

Made from metal with 100% wood cladding, this is the perfect solution for those who want to infuse a natural feel into their architectural space or intend to incorporate wood in their interior decor. What sets it apart is the ability to have it clad in the wood of your choice. Bring the beauty of nature to your spaces with a combination of cladding and lighting that suits your preferences.

Eşsiz doğal zarafet ve serinlik.

%100 ahşap kaplamalı metal malzemeden yapılan bu ürün, mimari mekanına doğal bir hava katmak isteyen veya iç dekorasyonunda ahşap kullanmayı planlayanlar için mükemmel bir çözümdür.

Onu diğerlerinden ayıran özellik, istediğiniz ahşap türüyle kaplanabilme özelliğidir. Tercihlerinize uygun kaplama ve aydınlatma kombinasyonları ile doğanın güzelliğini mekanlarınıza taşıyın.



Leaflet





# MAGNUM

Products never felt more special.

Equipped with a vertical cooling system, Magnum grabs the attention with its continuous neon lighting strip in the door, canopy and grilles.

The shelves feature specialized slots to maintain packaged products upright for clear visibility.

Ürünler hiç bu kadar özel hissettirmedi.

Dikey soğutma sistemi ile donatılmış Magnum, kapıda, tavanında ve ızgaralarında devam eden neon aydınlatma şeridi ile dikkat çeker.

Raflar, paketlenmiş ürünleri dik tutmak için özel olarak tasarlanmış yuvalara sahiptir, böylece net görünürlük sağlanır.





Leaflet

CUSTOM MADE



POWER

CUSTOM MADE



## BABY RS RED

Compact, fast and red.

Baby RS Red is tailored for those seeking a functional solution in small bars, buffets and tight spaces without compromising on brand visibility. It provides the perfect 'customized cooler' solution, offering choices in color, lighting, branding and sensor usage as required.

Kompakt, hızlı ve kırmızı.

Baby RS Red, küçük barlar, büfeler ve sıkı alanlar için işlevsel bir çözüm arayanlar için özel olarak tasarlanmıştır ve marka görünürlüğünden ödün vermez. Renk, aydınlatma, markalama ve sensör kullanımı gibi gereksinimlere göre seçenekler sunarak mükemmel bir 'özel soğutucu' çözümü sağlar.



Leaflet





## CAN COOLER

Versatile solutions for diverse needs.

Designed with rounded lines, this cooler provides a versatile cooling solution for various types of beverages, whether used inside vehicles, in open areas, at festivals, parties, or similar mobile organized events. Supported by accessories and customizable branding options, it seamlessly adapts to any setting.

Çeşitli ihtiyaçlar için çok yönlü çözümler.

Yuvarlak hatlara sahip tasarlanan bu soğutucu, araç içinde, açık alanlarda, festivallerde, partilerde veya benzeri mobil organizasyonlarda kullanılan çeşitli içecekler için çok yönlü bir soğutma çözümü sunar. Aksesuarlar ve özelleştirilebilir markalama seçenekleri ile desteklenerek her ortama mükemmel bir şekilde adapte olur.





# ACCESSORIES

## Aksesuarlar

Elevate your style with a variety of Can Cooler accessories. With optional wooden accessories, you can effortlessly showcase your well-preserved, fresh products and earn the admiration of your guests.

Stilinizi çeşitli Kutu Soğutucu aksesuarları ile yükseltin.

İsteğe bağlı ahşap aksesuarlar ile iyi korunmuş, taze ürünlerinizi kolayca sergileyebilir ve misafirlerinizin takdirini kazanabilirsiniz.



# LIFE



Designed to fulfill the requirements of corporate companies for family-type coolers in supermarket chains, Life provides solutions such as a slim model and interchangeable door-canopy and grille on the 3-door model. It transforms any location into a true

showroom. Its customizable designer lines can be adjusted to meet specific needs or brand aesthetics, seamlessly capturing the attention of both consumers and products.

Kurumsal şirketlerin süpermarket zincirlerinde aile tipi soğutucular için gereksinimlerini karşılamak üzere tasarlanan Life, ince bir model ve 3 kapılı modelde değiştirilebilir kapı-kanopi ve ızgara gibi çözümler sunar. Herhangi bir yeri gerçek bir sergi alanına dönüştürür.

Özelleştirilebilir tasarım çizgileri, belirli ihtiyaçları veya marka estetiğini karşılamak üzere ayarlanabilir, tüketicilerin ve ürünlerin dikkatini sorunsuz bir şekilde çeker.



Leaflet

# WORLD COLLECTION FAMILY



Leaflet

# KENT



This product enables brands to incorporate their unique elements into the design. It fosters brand awareness in consumers' minds and serves as an effective advertising channel wherever it is placed. Its triangular roof design, representing a sense of family culture, combined with LED options and branding areas, consistently draws attention. It is tailored to enhance sales potential in both outdoor and indoor locations.

Bu ürün, markaların tasarıma benzersiz öğelerini entegre etmelerine olanak tanır. Tüketicilerin zihninde marka bilinirliğini artırır ve yerleştirildiği her yerde etkili bir reklam kanalı olarak hizmet verir. Üçgen çatı tasarımı, aile kültürünü temsil ederken LED seçenekleri ve markalama alanlarıyla dikkat çeker. Hem açık hem de kapalı mekanlarda satış potansiyelini artırmak için özel olarak tasarlanmıştır.



Leaflet

# OPTIONS

## Opsiyonlar

## CABINET COLOURS / Renkler

									
RAL1000	RAL1001	RAL1002	RAL1003	RAL1004	RAL1005	RAL1006	RAL1007	RAL1011	RAL1012
									
RAL1013	RAL1014	RAL1015	RAL1016	RAL1017	RAL1018	RAL1019	RAL1020	RAL1021	RAL1023
									
RAL1024	RAL1027	RAL1028	RAL1032	RAL1033	RAL1034	RAL2000	RAL2001	RAL2002	RAL2003
									
RAL2004	RAL2008	RAL2009	RAL2010	RAL2011	RAL2012	RAL3000	RAL3001	RAL3002	RAL3003
									
RAL3004	RAL3005	RAL3007	RAL3009	RAL3011	RAL3012	RAL3013	RAL3014	RAL3015	RAL3016
									
RAL3017	RAL3018	RAL3020	RAL3022	RAL3027	RAL3031	RAL4001	RAL4002	RAL4003	RAL4004
									
RAL4005	RAL4006	RAL4007	RAL4008	RAL4009	RAL4010	RAL5000	RAL5004	RAL5005	RAL5010
									
RAL6005	RAL6008	RAL6009	RAL6010	RAL6013	RAL6014	RAL6015	RAL6018	RAL6019	RAL6020
									
RAL7033	RAL7034	RAL7036	RAL7037	RAL7043	RAL7045	RAL8000	RAL8001	RAL8004	RAL8015
									
RAL8023	RAL9004	RAL9005	RAL9006	RAL9007	RAL9010	RAL9011	RAL9016	RAL9017	RAL9018

\* RAL colour options include the body and door handle.  
\* RAL renk seçenekleri gövde ve kapı kolu için geçerlidir.

# SHELVES / Raflar

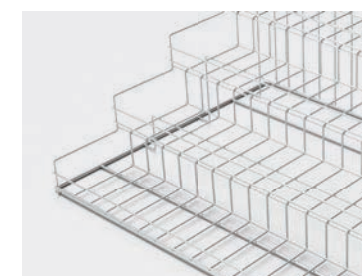
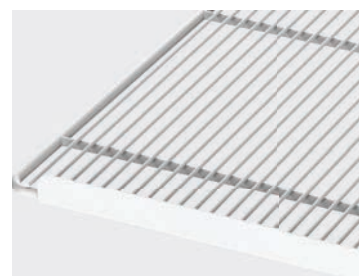
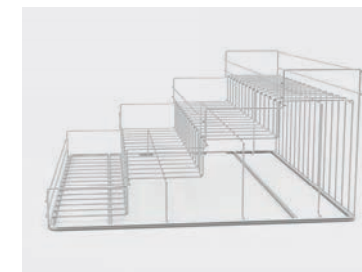
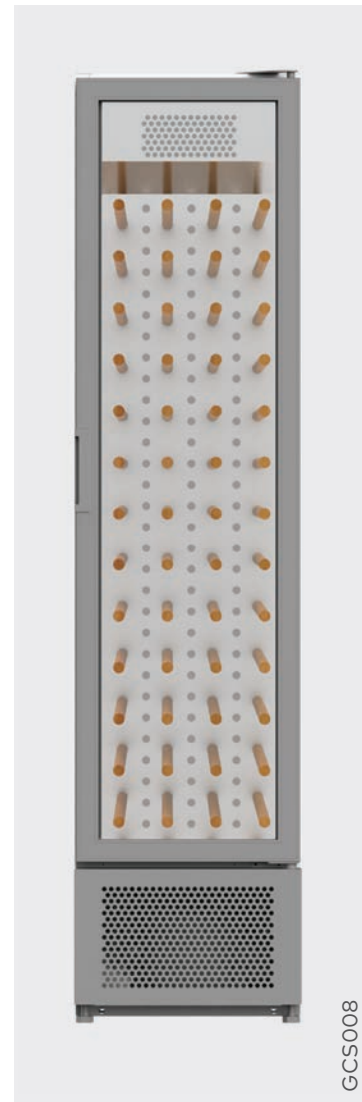

Standard

Wooden Front

Branded Wood

Chrome Front

Stepped

Basket

Wooden

Wooden Line

# GLASSES / Camlar



Low-E glass rejects UV light and solar heat  
Low-E cam UV ışığını ve güneş ısısını reddeder

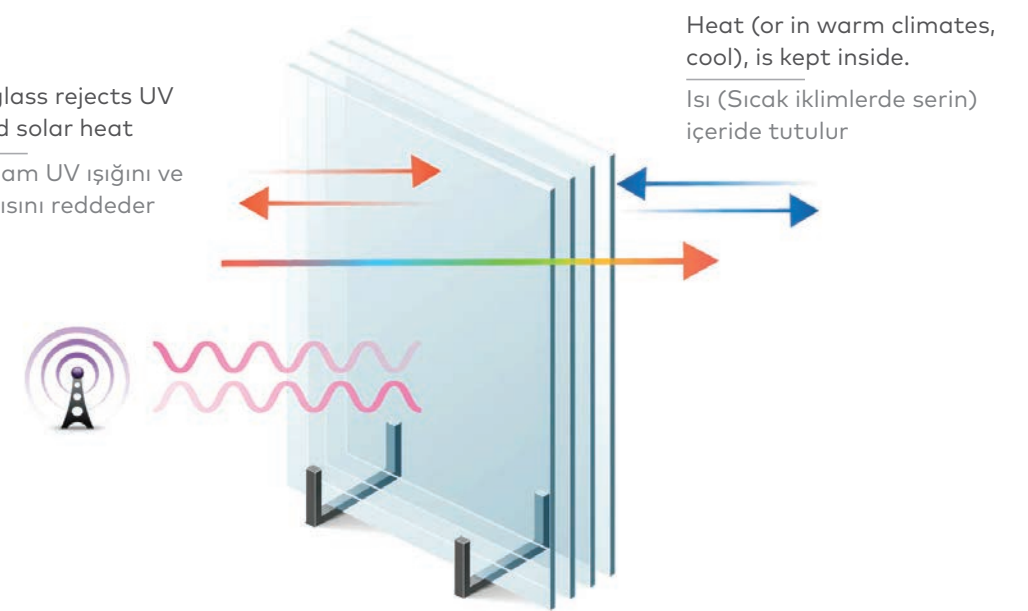

## FLUSH REVERSIBLE DOOR / Kapı Yönü Deęiřtirme



Two-way door use by changing the location of the lower upper hinge

Çift yönlü kapı, alt ve üst menteşelerin yerini deęiřtirerek iki yönlü kullanım sağlar.

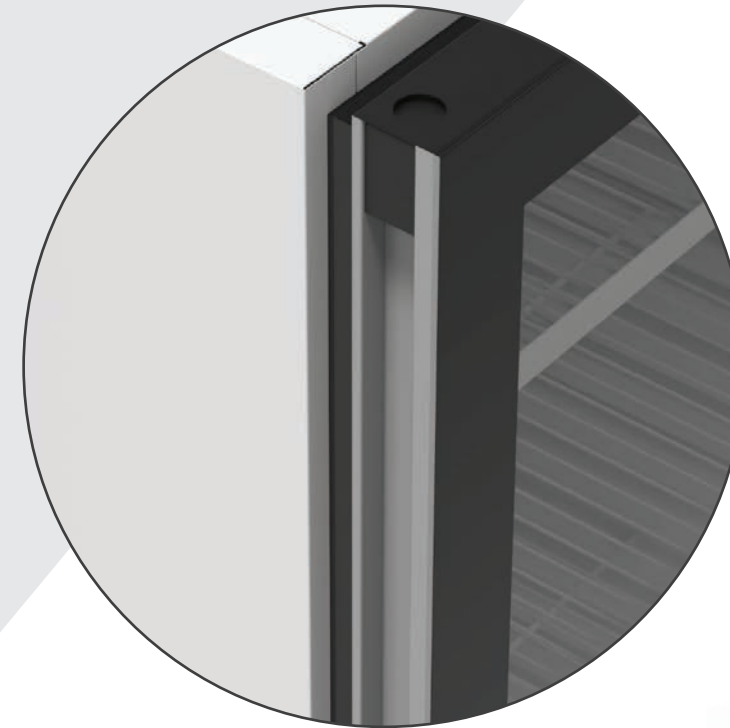



DOOR HANDLE / Tutamak



Standard



Vintage

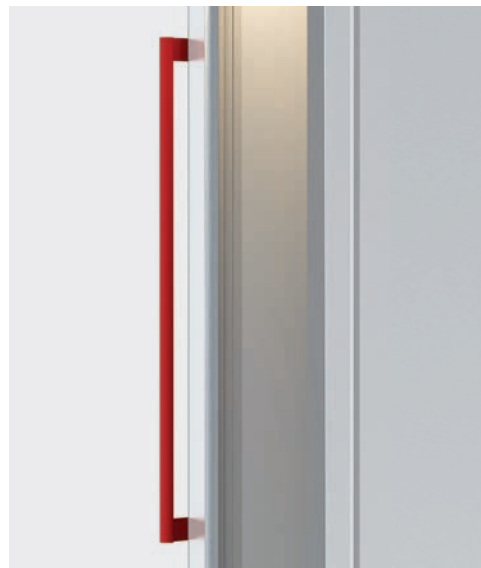

Reserve



WC



CC



Push

BETA SERIES DOOR TYPE / Beta Serisi Kapı Tipleri



BS001

BS002

BS003

BS004

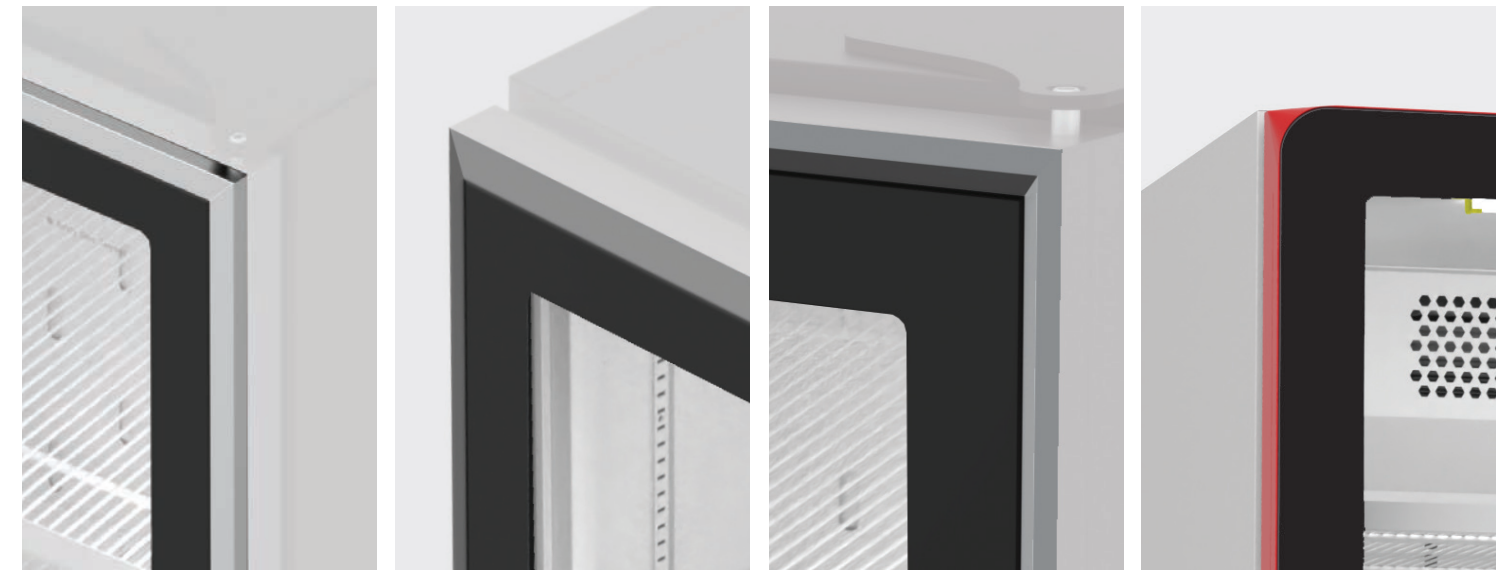

BS005

BS006

BS007

BS008

ALFA SERIES DOOR TYPE / Alfa Serisi Kapı Tipleri

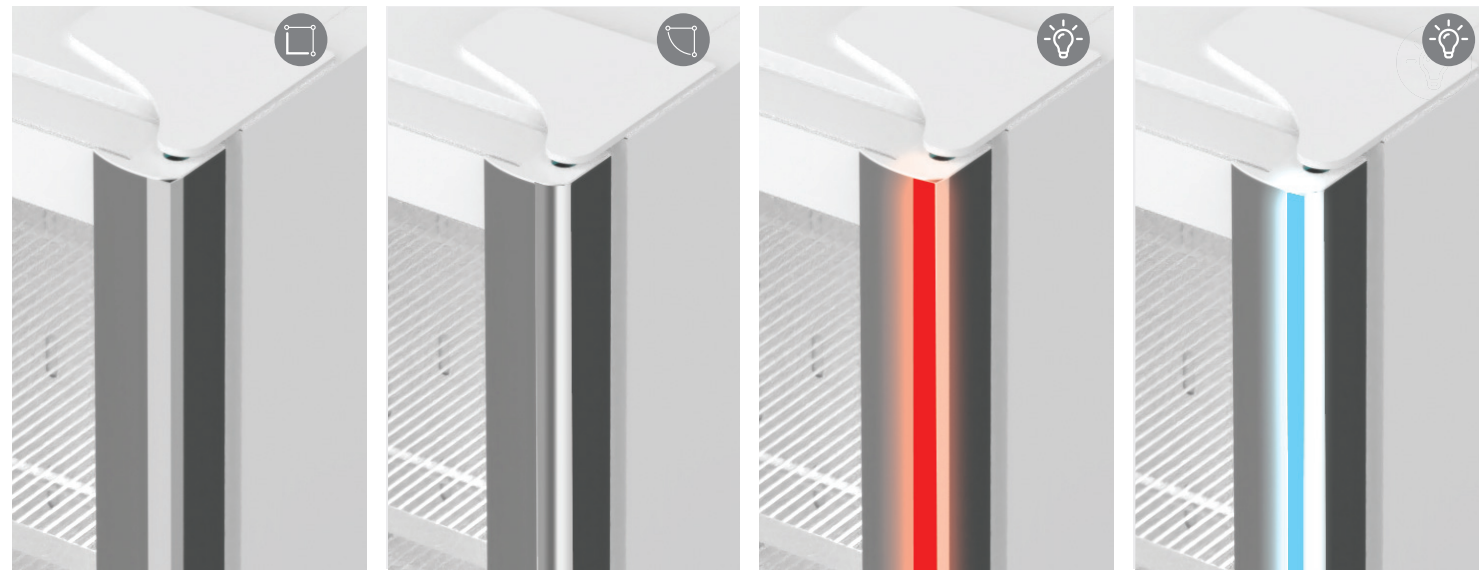

AS001

AS002

AS003

AS004

CUSTOM MADE

COATING / Kaplamalar



Standard

GCT001

Corten

GCT002

Red

GCT003



Chrome

GCT004

Nickel

GCT005

Wooden

GCT006

CUSTOM MADE

GANOPY / Kanopiler

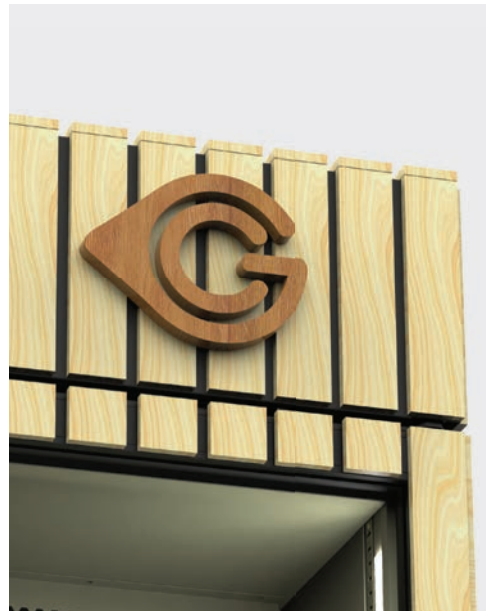
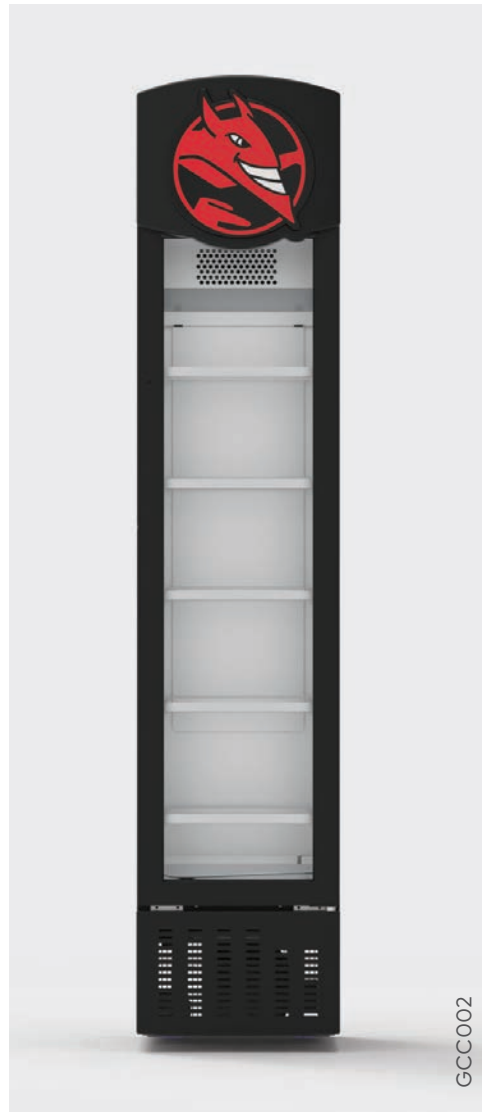

RIGK PLATE / Tekmelik

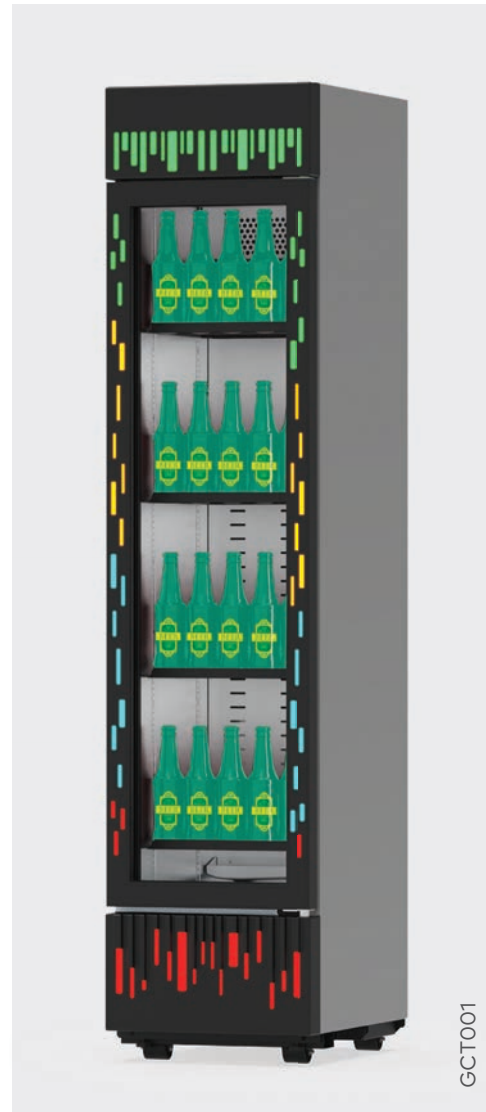

GCT001



GCT002



GCT003



GCT004



GCT005



GCT006



BACK PLATE DESIGNS / Arka Saç Tasarımları

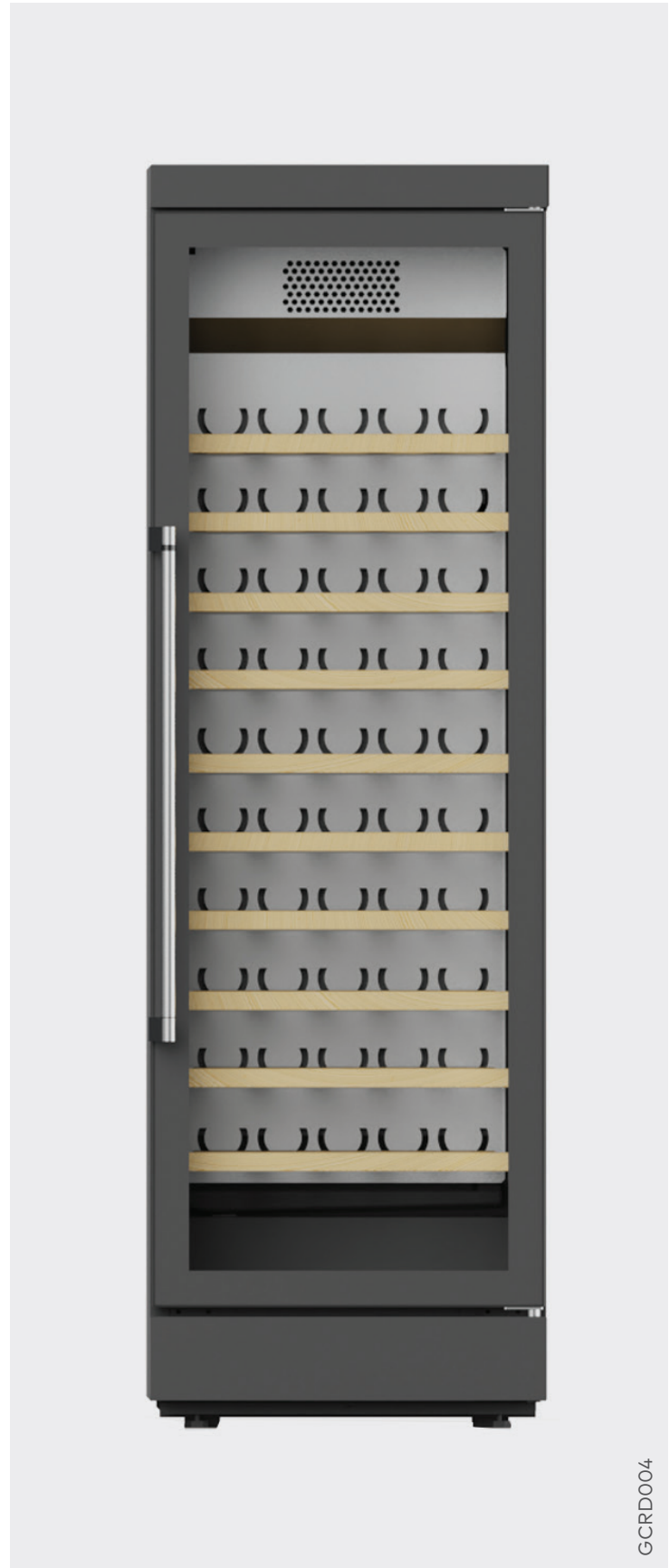
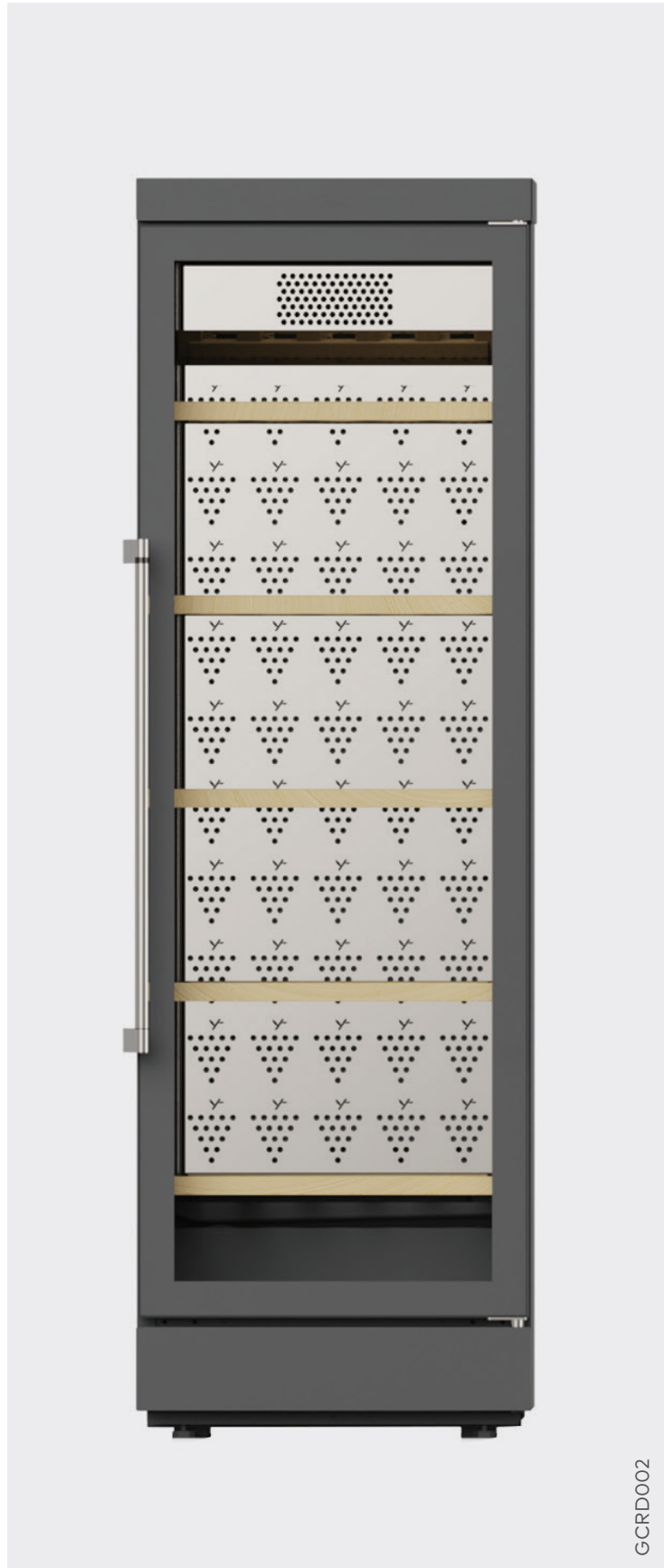
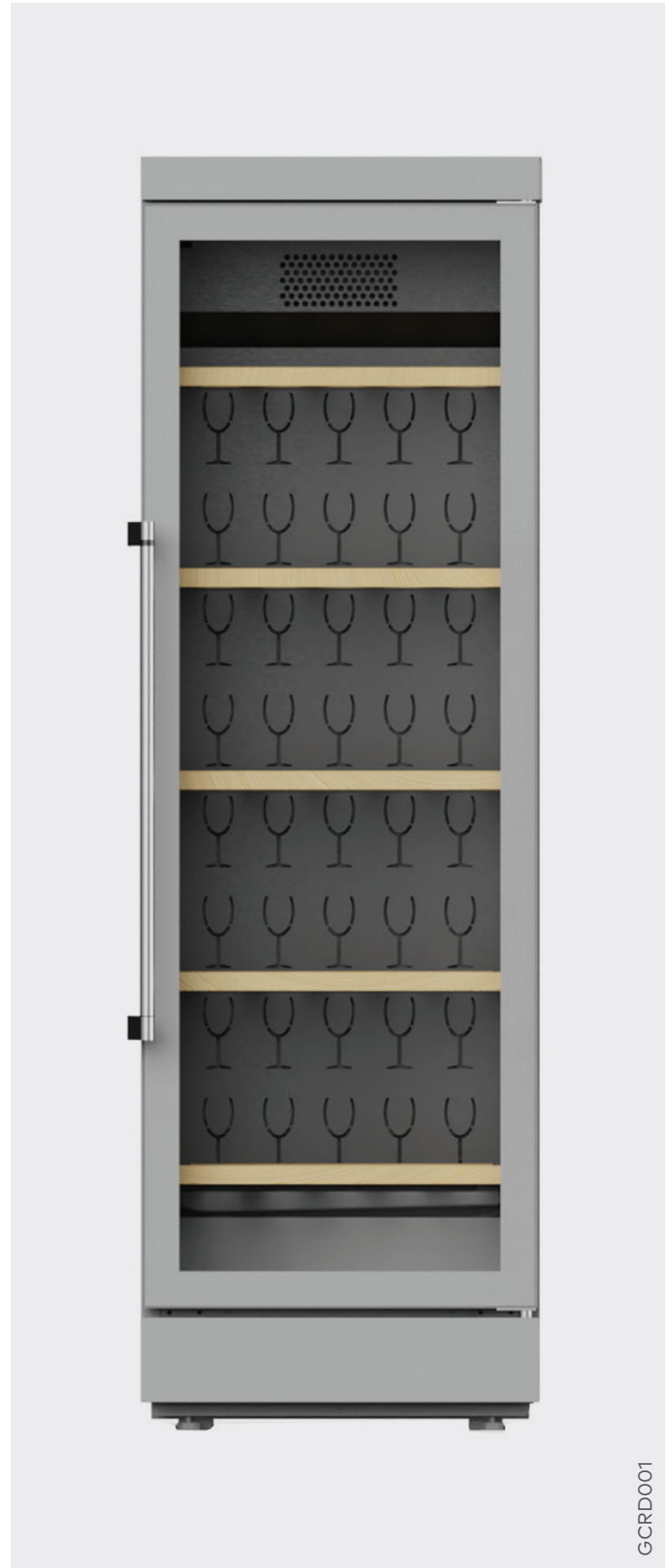

# LED LIGHTING / LED Aydınlatma

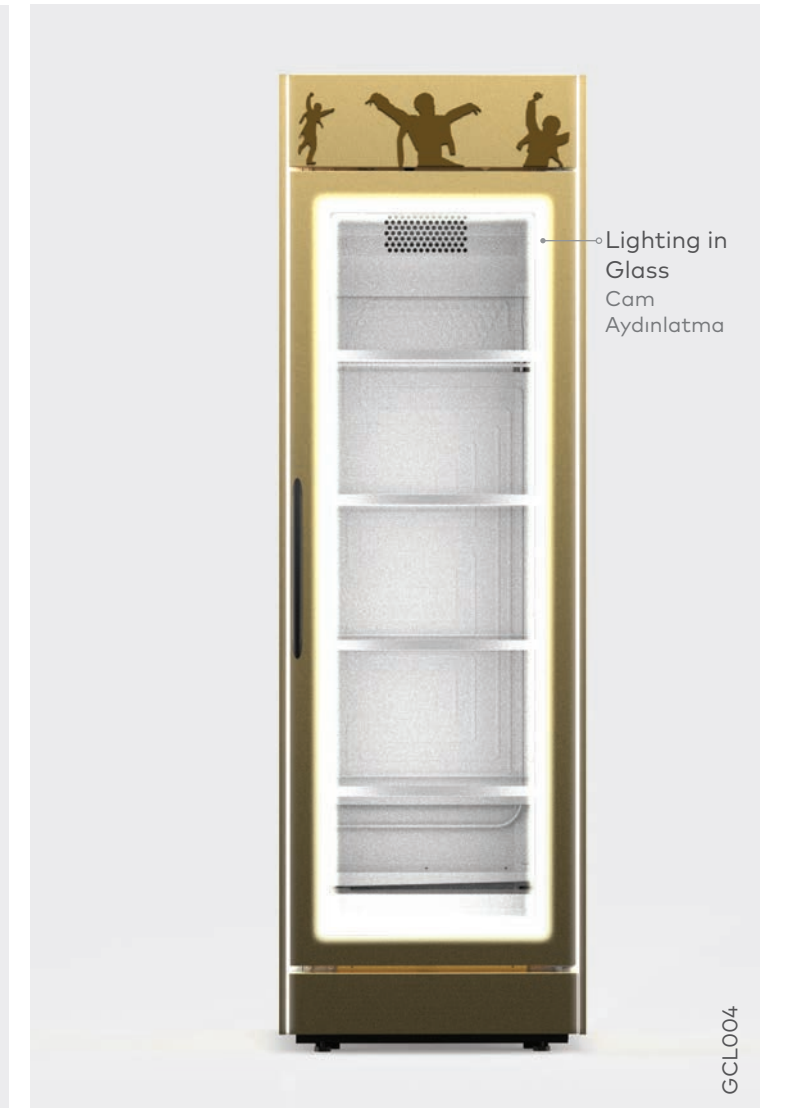
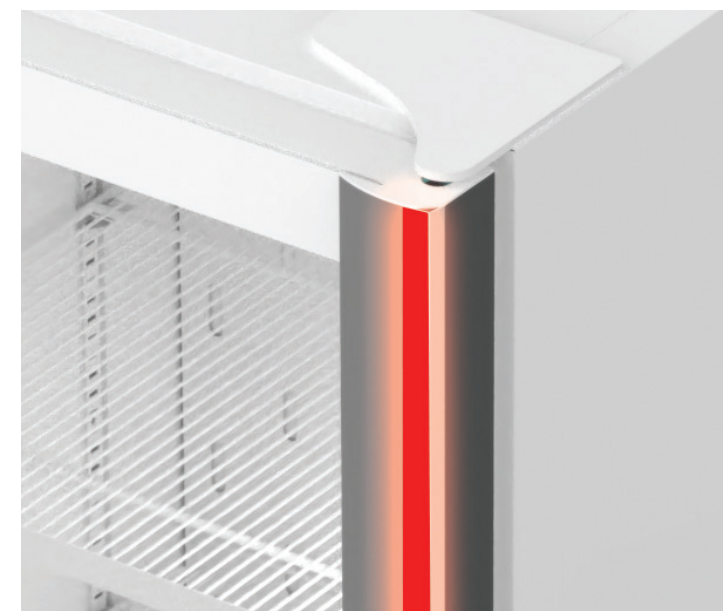
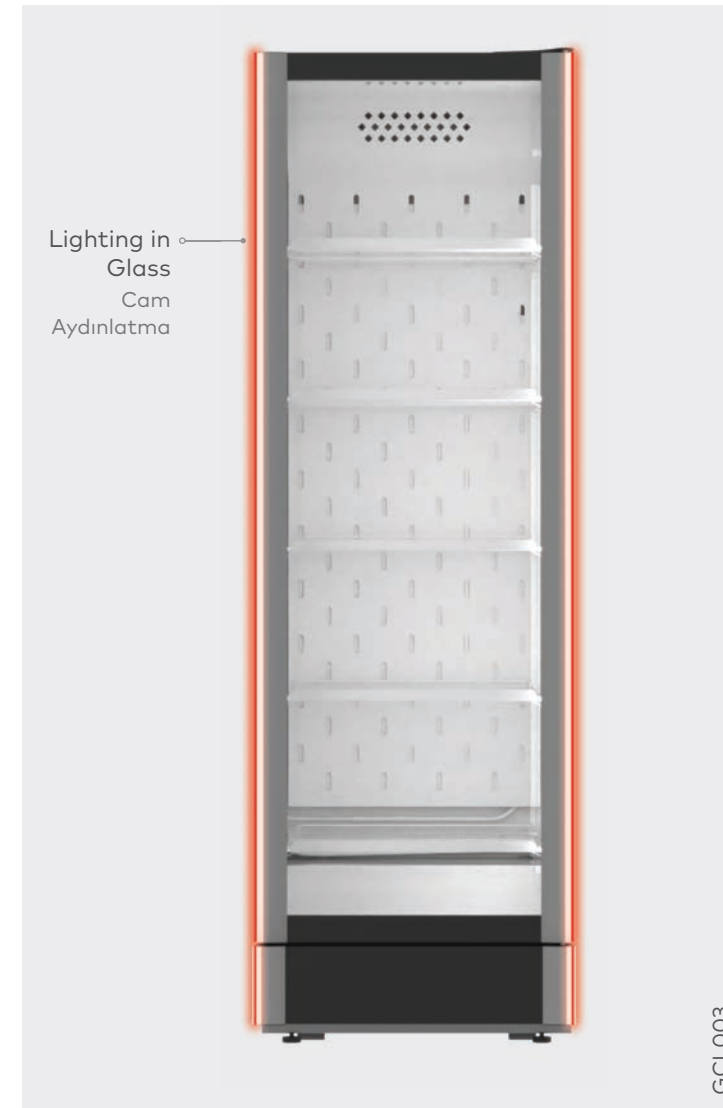



-  **Wind-Resistant**  
Rüzgara Dayanıklı
-  **Theft-Deterrent**  
Hırsızlığa Karşı Caydırıcı
-  **Water-Resistant**  
Su Geçirmez
-  **Energy Saving**  
Enerji Tasarrufu
-  **Easy to Use**  
Kullanım Kolaylığı
-  **Durable**  
Dayanıklı
-  **Increases Visibility**  
Görünürlüğü Arttırır



## EGIDA

### Egida: The Guardian of Your Security.

Once upon a time, in the realm of the ancient Greek gods, the mighty Zeus and the wise goddess Athena joined forces to protect the world and keep their people safe.

The miraculous result of Athena's wisdom and Zeus's power was something they named "Egida." Egida was a magnificent shield that adorned the world, featuring the head of Medusa. This sacred shield provided protection against all manner of dangers, allowing people to live in peace.

As the years passed, the power and protective qualities of Egida spread to every corner of the world. Now, the power of this unique shield is within your reach. Egida, as a strong and reliable guardian, will protect you from the risks that surround you while reflecting your style and elegance.

Egida revives the power of ancient gods in the modern world. When you want to feel safe or need protection in the most challenging moments, Egida will be by your side.

### Egida: Güvenliğinizin Koruyucusu.

Bir zamanlar, antik Yunan tanrıalarının diyarında, kudretli Zeus ve bilge tanrıça Athena, dünyayı korumak ve halklarını güvende tutmak için güçlerini birleştirdi. Athena'nın bilgeliği ve Zeus'un gücünün mucizevi sonucu olarak "Egida" adını verdikleri bir şey yarattılar. Egida, Medusa'nın başını tasvir eden muhteşem bir kalkan olarak dünyayı süsledi. Bu kutsal kalkan, her türlü tehlikeye karşı koruma sağlayarak insanların huzur içinde yaşamasına olanak tanıdı.

Yıllar geçtikçe, Egida'nın gücü ve koruyucu özellikleri dünyanın her köşesine yayıldı. Şimdi, bu eşsiz kalkanın gücü karşınızda. Egida, güçlü ve güvenilir bir koruyucu olarak, etrafınızı saran risklerden sizi korurken tarzınızı ve zarafetinizi yansıtacaktır. Egida, antik tanrıların gücünü modern dünyada yeniden canlandırıyor. Kendinizi güvende hissetmek istediğinizde ya da en zorlu anlarda korumaya ihtiyaç duyduğunuzda, Egida yanınızda olacak.



Movie





ALL MODELS  
Tüm Modeller



## Single Door Vertical Coolers

Tek Kapılı Dikey Soğutucular

### Technical Specifications

Teknik Özellikler



	180 C	180 WOC	180 EC	180 EWOC	270 C	270 WOC
<b>Dimensions / Boyutlar</b>						
Gross Volume (L) Brüt Hacim	197	197	195	195	259	259
Net Volume (L) Net Hacim	184	184	183	183	242	242
Internal Dimensions (w*d*h) (mm) / İç Ölçüler	357*345*1410	357*345*1410	328,5*345*1417	328,5*345*1417	355*465,5*1442	355*465,5*1442
External Dimensions (w*d*h) (mm) / Dış Ölçüler	435*517*2010	435*517*1832	435*512*2010	435*512*1832	455*623*2031	455*623*1853,5
External Dimensions with Package (w*d*h) (mm) / Ambalajlı Dış Ölçüler	485*560*2135	485*560*1960	485*560*2140	485*560*1965	493*663*2125	493*663*1947,5
<b>Packaging / Paketleme</b>						
Net Weight (kg) Net Ağırlık	70	73			93	90
Gross Weight (kg) Brüt Ağırlık	78	79			101	98
<b>Product Loading / Ürün Yükleme</b>						
Number of Products Loaded on the Width (330 ml - Ø 66,3 mm) Genişliğe Yüklenebilir Ürün Adedi	5	5	4	4	5	5
Number of Products Loaded on the Depth (330 ml - Ø 66,3 mm) Derinliğe Yüklenebilir Ürün Adedi	4	4	4	4	6	6
Number of Products Loaded on the Width (330 ml - Ø 57 mm) Genişliğe Yüklenebilir Ürün Adedi	6	6	5	5	6	6
Number of Products Loaded on the Depth (330 ml - Ø 57 mm) Derinliğe Yüklenebilir Ürün Adedi	5	5	5	5	6	6
Product Display Area (m <sup>2</sup> ) Ürünün Kapladığı Alan	0,27	0,27	0,27	0,27	0,283	0,282
Can Loading Unit (330 ml - Ø 66,3 mm) / Kutu Yükleme Adedi	195	195	128	128	320	300
Bottle Loading Unit (500 ml) Şişe Yükleme Adedi	120	120	100	100	170	170
<b>Technical Specifications / Teknik Özellikler</b>						
Number of Shelves Raf Sayısı	5	5	5	5	5	5
Insulation Thickness (mm) İzolasyon Kalınlığı	40	40	38	40	50	50
Working Temperature Range °C Çalışma Sıcaklık Aralığı	0 / +10 °C	0 / +10 °C	0 / +10 °C	0 / +10 °C	0 / +10 °C	0 / +10 °C
Refrigerant Soğutucu Gaz	R600a	R600a	R600a	R600a	R600a	R600a
Climate Class İklim Sınıfı	B/C	B/C	B/C	B/C	B/C	B/C
Supply Voltage Besleme Gerilimi	220-240 / 50 V/Hz	220-240 / 50 V/Hz	220-240 / 50 V/Hz	220-240 / 50 V/Hz	220-240 / 50 V/Hz	220-240 / 50 V/Hz
<b>Logistics / Lojistik</b>						
20" / 40" / 40H" Container Loading Unit / 20" / 40" / 40H" Konteyner Yükleme Adedi	48 / 96 / 96	48 / 96 / 96	48 / 96 / 96	48 / 96 / 96	36 / 72 / 72	36 / 72 / 72
13,6 m Truck Loading Unit 13,6 m Tır Yükleme Adedi	120	120	120	120	95	95

## Single Door Vertical Coolers

Tek Kapılı Dikey Soğutucular

### Technical Specifications

Teknik Özellikler



	290 C	290 WOC	295 C	295 WOC	375 EC	375 EWOC
<b>Dimensions / Boyutlar</b>						
Gross Volume (L) Brüt Hacim	312	312	331	331	384	384
Net Volume (L) Net Hacim	305	305	325	325	367	367
Internal Dimensions (w*d*h) (mm) / İç Ölçüler	424*474.5*1408	424*474.5*1408	424*498*1499	424*498*1499	517*470*1555	517*470*1555
External Dimensions (w*d*h) (mm) / Dış Ölçüler	500*640*2023	500*640*1820	500*640*2147	500*640*1920	590*629.5*2006	590*629.5*1817
External Dimensions with Package (w*d*h) (mm) / Ambalajlı Dış Ölçüler	544*696*2179	544*696*1954	544*696*2300	544*696*2054	605*655*2142	605*655*1953
<b>Packaging / Paketleme</b>						
Net Weight (kg) Net Ağırlık	99	93	-	-	72	67,8
Gross Weight (kg) Brüt Ağırlık	104	99	-	-	80	75,8
<b>Product Loading / Ürün Yükleme</b>						
Number of Products Loaded on the Width (330 ml - Ø 66,3 mm) Genişliğe Yüklenebilir Ürün Adedi	6	6	6	6	7(+)	7(+)
Number of Products Loaded on the Depth (330 ml - Ø 66,3 mm) Derinliğe Yüklenebilir Ürün Adedi	6	6	6	7	6	6
Number of Products Loaded on the Width (330 ml - Ø 57 mm) Genişliğe Yüklenebilir Ürün Adedi	7	7	7	7	8(+)	8(+)
Number of Products Loaded on the Depth (330 ml - Ø 57 mm) Derinliğe Yüklenebilir Ürün Adedi	7	7	7	7	7	7
Product Display Area (m <sup>2</sup> ) Ürünün Kapladığı Alan	0,32	0,32	0,32	0,32	0,344	0,37
Can Loading Unit (330 ml - Ø 66,3 mm) / Kutu Yükleme Adedi	354	354	390	390	399	399
Bottle Loading Unit (500 ml) Şişe Yükleme Adedi	174	174	174	174	231	231
<b>Technical Specifications / Teknik Özellikler</b>						
Number of Shelves Raf Sayısı	5	5	5	5	5(+)	5(+)
Insulation Thickness (mm) İzolasyon Kalınlığı	38	38	38	38	38,1	38,1
Working Temperature Range °C Çalışma Sıcaklık Aralığı	0 / +10 °C	0 / +10 °C	0 / +10 °C	0 / +10 °C	0 / +10 °C	0 / +10 °C
Refrigerant Soğutucu Gaz	R600a	R600a	R600a	R600a	R600a	R600a
Climate Class İklim Sınıfı	B/C	B/C	B/C	B/C	B/C	B/C
Supply Voltage Besleme Gerilimi	220-240 / 50 V/Hz	220-240 / 50 V/Hz	220-240 / 50 V/Hz	220-240 / 50 V/Hz	220-240 / 50 V/Hz	220-240 / 50 V/Hz
<b>Logistics / Lojistik</b>						
20" / 40" / 40H" Container Loading Unit / 20" / 40" / 40H" Konteyner Yükleme Adedi	32 / 68 / 68	32 / 68 / 68	32 / 68 / 68	32 / 68 / 68	27(+)/ 57(+)/ 57 (+)	27(+)/ 57(+)/ 57 (+)
13,6 m Truck Loading Unit 13,6 m Tır Yükleme Adedi	76	76	76	76	76 (+)	76 (+)

## Single Door Vertical Coolers

Tek Kapılı Dikey Soğutucular

### Technical Specifications

Teknik Özellikler



	250 C	250 EC	250 WOC	250 EWOC	380 WOC	380 C	410 WOC
<b>Dimensions / Boyutlar</b>							
Gross Volume (L) Brüt Hacim	252	258	252	258	363	363	415
Net Volume (L) Net Hacim	244	246	244	246	356	356	407
Internal Dimensions (w*d*h) (mm) / İç Ölçüler	490*444.5*1091	517*470*1091	490*444.5*1091	517*470*1091	490*444*1555	490*444*1555	490*444*1737
External Dimensions (w*d*h) (mm) / Dış Ölçüler	590*622.5*1540.5	590*622.5*1540.5	590*622.5*1365	590*622.5*1365	590*621*1827	590*621*2005	590*624*2024
External Dimensions with Package (w*d*h) (mm) / Ambalajlı Dış Ölçüler	615*660*1660	615*660*1660	615*660*1505	615*660*1505	605*646*1963	605*646*2141	622*644*2164
<b>Packaging / Paketleme</b>							
Net Weight (kg) Net Ağırlık	81	76	78	73	96	100	105
Gross Weight (kg) Brüt Ağırlık	87	82	83	78	101.5	106	115
<b>Product Loading / Ürün Yükleme</b>							
Number of Products Loaded on the Width (330 ml - Ø 66,3 mm) Genişliğe Yüklene Ürün Adedi	7	7	7	7	7	7	7
Number of Products Loaded on the Depth (330 ml - Ø 66,3 mm) Derinliğe Yüklene Ürün Adedi	6	5	6	5	6	6	6
Number of Products Loaded on the Width (330 ml - Ø 57 mm) Genişliğe Yüklene Ürün Adedi	8	8	8	8	8	8	8
Number of Products Loaded on the Depth (330 ml - Ø 57 mm) Derinliğe Yüklene Ürün Adedi	7	6	7	6	7	7	6
Product Display Area (m²) Ürünün Kapladığı Alan	0,367	0,367	0,369	0,367	0,365	0,365	0,367
Can Loading Unit (330 ml - Ø 66,3 mm) / Kutu Yükleme Adedi	308	231	308	231	476	476	490
Bottle Loading Unit (500 ml) Şişe Yükleme Adedi	140	154	189	154	221	221	231
<b>Technical Specifications / Teknik Özellikler</b>							
Number of Shelves Raf Sayısı	4	4	4	4	5	5	5
Insulation Thickness (mm) İzolasyon Kalınlığı	50	50	50	38	50	50	50
Working Temperature Range °C Çalışma Sıcaklık Aralığı	0 / +10 °C	0 / +10 °C	0 / +10 °C	0 / +10 °C	0 / +10 °C	0 / +10 °C	0 / +10 °C
Refrigerant Soğutucu Gaz	R600a	R600a	R600a	R600a	R600a	R600a	R600a
Climate Class İklim Sınıfı	B/C	B/C	B/C	B/C	B/C	B/C	B/C
Supply Voltage Besleme Gerilimi	220-240 / 50 V/Hz	220-240 / 50 V/Hz	220-240 / 50 V/Hz	220-240 / 50 V/Hz	220-240 / 50 V/Hz	220-240 / 50 V/Hz	220-240 / 50 V/Hz
<b>Logistics / Lojistik</b>							
20" / 40" / 40H" Container Loading Unit / 20" / 40" / 40H" Konteyner Yükleme Adedi	26 / 57 / 57	26 / 57 / 57	26 / 57 / 57	26 / 57 / 57	27 / 57 / 57	27 / 57 / 57	27 / 57 / 57
13,6 m Truck Loading Unit 13,6 m Tır Yükleme Adedi	66	66	66	66	84	84	63

## Single Door Vertical Coolers

Tek Kapılı Dikey Soğutucular

### Technical Specifications

Teknik Özellikler



	410 EWOC	390 C	390 WOC	420 C	420 WOC	400 WOC
<b>Dimensions / Boyutlar</b>						
Gross Volume (L) Brüt Hacim	421	365	365	374	374	423
Net Volume (L) Net Hacim	409	355	355	365	365	414
Internal Dimensions (w*d*h) (mm) / İç Ölçüler	517*470*1737	490*463.5*1458.5	490*463.5*1458.5	489*463.5*1499	489*463.5*1499	490*444*1862
External Dimensions (w*d*h) (mm) / Dış Ölçüler	590*624*2024	590*621*2005	590*621*18 44	590*640*2147	590*640*1980	590*624*2024
External Dimensions with Package (w*d*h) (mm) / Ambalajlı Dış Ölçüler	622*644*2164	605*646*2145	605*646*1984	622*662*2287	622*662*2120	622*644*2164
<b>Packaging / Paketleme</b>						
Net Weight (kg) Net Ağırlık	100	102	100	-	120	125
Gross Weight (kg) Brüt Ağırlık	110	108.5	110	-	130	135
<b>Product Loading / Ürün Yükleme</b>						
Number of Products Loaded on the Width (330 ml - Ø 66,3 mm) Genişliğe Yüklene Ürün Adedi	7	7	7	7	7	7
Number of Products Loaded on the Depth (330 ml - Ø 66,3 mm) Derinliğe Yüklene Ürün Adedi	5	6	6	6	6	6
Number of Products Loaded on the Width (330 ml - Ø 57 mm) Genişliğe Yüklene Ürün Adedi	8	8	8	8	8	8
Number of Products Loaded on the Depth (330 ml - Ø 57 mm) Derinliğe Yüklene Ürün Adedi	6	7	7	7	7	6
Product Display Area (m²) Ürünün Kapladığı Alan	0,367	0,379	0,357	0,415	0,415	0,367
Can Loading Unit (330 ml - Ø 66,3 mm) / Kutu Yükleme Adedi	426	455	455	497	497	518
Bottle Loading Unit (500 ml) Şişe Yükleme Adedi	238	245	245	238	238	231
<b>Technical Specifications / Teknik Özellikler</b>						
Number of Shelves Raf Sayısı	5	5	5	5	5	5
Insulation Thickness (mm) İzolasyon Kalınlığı	38	50	50	50	50	50
Working Temperature Range °C Çalışma Sıcaklık Aralığı	0 / +10 °C	0 / +10 °C	0 / +10 °C	0 / +10 °C	0 / +10 °C	0 / +10 °C
Refrigerant Soğutucu Gaz	R600a	R600a	R600a	R600a	R600a	R600a
Climate Class İklim Sınıfı	B/C	B/C	B/C	B/C	B/C	B/C
Supply Voltage Besleme Gerilimi	220-240 / 50 V/Hz	220-240 / 50 V/Hz	220-240 / 50 V/Hz	220-240 / 50 V/Hz	220-240 / 50 V/Hz	220-240 / 50 V/Hz
<b>Logistics / Lojistik</b>						
20" / 40" / 40H" Container Loading Unit / 20" / 40" / 40H" Konteyner Yükleme Adedi	27 / 57 / 57	27 / 57 / 57	27 / 57 / 57	27 / 57 / 57	27 / 57 / 57	27 / 57 / 57
13,6 m Truck Loading Unit 13,6 m Tır Yükleme Adedi	63	84	84	63	63	63

## Single Door Vertical Coolers

Tek Kapılı Dikey Soğutucular

### Technical Specifications

Teknik Özellikler

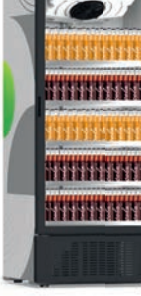

**670 C**

**670 WOC**

**660 C**

**660 WOC**

**900 C SD**

**900 WOC SD**

Dimensions / Boyutlar	Dimensions / Boyutlar						
	670 C	670 WOC	660 C	660 WOC	900 C SD	900 WOC SD	
Gross Volume (L) Brüt Hacim	658	670	665	677	787	771	
Net Volume (L) Net Hacim	603	616	606	619	722	710	
Internal Dimensions (w*d*h) (mm) / İç Ölçüler	624*643*1608	624*643*1608	690*553*1702	690*553*1702	805*595*1570	805*595*1570	
External Dimensions (w*d*h) (mm) / Dış Ölçüler	725*768*2061	725*768*2066	791*687*2145	791*687*2145	907*731*2015	907*731*2020	
External Dimensions with Package (w*d*h) (mm) / Ambalajlı Dış Ölçüler	757*790*2201	757*790*2206	823*709*2270	823*709*2270	945*770*2150	945*770*2155	
Net Weight (kg) Net Ağırlık	134	136	150	150	157	154	
Gross Weight (kg) Brüt Ağırlık	144	146	170	170	168	165	
Product Loading / Ürün Yükleme	Number of Products Loaded on the Width (330 ml - Ø 66,3 mm) Genişliğe Yüklene Ürün Adedi	9	9	10	10	12	12
	Number of Products Loaded on the Depth (330 ml - Ø 66,3 mm) Derinliğe Yüklene Ürün Adedi	8	8	7	7	7	7
	Number of Products Loaded on the Width (330 ml - Ø 57 mm) Genişliğe Yüklene Ürün Adedi	10	10	11	11	13	13
	Number of Products Loaded on the Depth (330 ml - Ø 57 mm) Derinliğe Yüklene Ürün Adedi	9	9	8	8	8	8
Product Display Area (m²) Ürünün Kapladığı Alan	0,557	0,557	0,543	0,543	0,664	0,664	
Can Loading Unit (330 ml - Ø 66,3 mm) / Kutu Yükleme Adedi	792	792	790	790	860	860	
Bottle Loading Unit (500 ml) Şişe Yükleme Adedi	360	360	420	420	420	420	
Technical Specifications / Teknik Özellikler	Number of Shelves Raf Sayısı	5	5	5	5	5	5
	Insulation Thickness (mm) İzolasyon Kalınlığı	50	50	50	50	50	50
	Working Temperature Range °C Çalışma Sıcaklık Aralığı	0 / +10 °C	0 / +10 °C	0 / +10 °C	0 / +10 °C	1 / +10 °C	0 / +10 °C
	Refrigerant Soğutucu Gaz	R290a	R290a	R290a	R290a	R290a	R290a
Climate Class İklim Sınıfı	B/C	B/C	B/C	B/C	B/C	B/C	
Supply Voltage Besleme Gerilimi	220-240 / 50 V/Hz	220-240 / 50 V/Hz	220-240 / 50 V/Hz	220-240 / 50 V/Hz	220-240 / 50 V/Hz	220-240 / 50 V/Hz	
Logistics / Lojistik	20" / 40" / 40H" Container Loading Unit / 20" / 40" / 40H" Konteyner Yükleme Adedi	21 / 42 / 42	21 / 42 / 42	23 / 42 / 42	23 / 42 / 42	18 / 36 / 36	18 / 36 / 36
	13,6 m Truck Loading Unit 13,6 m Tır Yükleme Adedi	51	51	54	54	42	42

## Double Door Vertical Coolers

Çift Kapılı Dikey Soğutucular

### Technical Specifications

Teknik Özellikler



**900 C**

**900 WOC**

**900 WOC Sliding**

**1200 WOC**

**1500 WOC ST DD**

Dimensions / Boyutlar	Dimensions / Boyutlar					
	900 C	900 WOC	900 WOC Sliding	1200 WOC	1500 WOC ST DD	
Gross Volume (L) Brüt Hacim	740	749	749	1188	1280	
Net Volume (L) Net Hacim	673	683	683	1093	1264	
Internal Dimensions (w*d*h) (mm) / İç Ölçüler	805*595*1570	805*595*1570	805*595*1570	1102x468x1694	1400*551*1582	
External Dimensions (w*d*h) (mm) / Dış Ölçüler	907*731*2015	907*731*2020	907*671*2020	1204x600x2145	1500*677*2021	
External Dimensions with Package (w*d*h) (mm) / Ambalajlı Dış Ölçüler	945*770*2150	945*770*2155	945*700*2155	1240x640x2280	1532*699*2161	
Net Weight (kg) Net Ağırlık	157	154	151	208	216	
Gross Weight (kg) Brüt Ağırlık	168	165	161	222	222	
Product Loading / Ürün Yükleme	Number of Products Loaded on the Width (330 ml - Ø 66,3 mm) Genişliğe Yüklene Ürün Adedi	12	12	12	16	21
	Number of Products Loaded on the Depth (330 ml - Ø 66,3 mm) Derinliğe Yüklene Ürün Adedi	7	7	7	5	6
	Number of Products Loaded on the Width (330 ml - Ø 57 mm) Genişliğe Yüklene Ürün Adedi	13	13	13	18	24
	Number of Products Loaded on the Depth (330 ml - Ø 57 mm) Derinliğe Yüklene Ürün Adedi	8	8	8	5	7
Product Display Area (m²) Ürünün Kapladığı Alan	0,664	0,664	0,608	0,772	1,005	
Can Loading Unit (330 ml - Ø 66,3 mm) / Kutu Yükleme Adedi	968	968	968	800	1355	
Bottle Loading Unit (500 ml) Şişe Yükleme Adedi	420	420	420	400	616	
Technical Specifications / Teknik Özellikler	Number of Shelves Raf Sayısı	5	5	5	5	2*5
	Insulation Thickness (mm) İzolasyon Kalınlığı	50	50	50	50	50
	Working Temperature Range °C Çalışma Sıcaklık Aralığı	0 / +10 °C	0 / +10 °C	0 / +10 °C	4 / +12 °C	0/ 10 C°
	Refrigerant Soğutucu Gaz	R290a	R290a	R290a	R290a	R290a
Climate Class İklim Sınıfı	B/C	B/C	B/C	B/C	B/C	
Supply Voltage Besleme Gerilimi	220-240 / 50 V/Hz	220-240 / 50 V/Hz	220-240 / 50 V/Hz	220-240 / 50 V/Hz	220-240 / 50 V/Hz	
Logistics / Lojistik	20" / 40" / 40H" Container Loading Unit / 20" / 40" / 40H" Konteyner Yükleme Adedi	18 / 36 / 36	18 / 36 / 36	18 / 36 / 36	12 / 30 / 30	11 / 24 / 24
	13,6 m Truck Loading Unit 13,6 m Tır Yükleme Adedi	42	42	42	33	27

## Double Door Vertical Coolers

Çift Kapılı Dikey Soğutucular

### Technical Specifications

Teknik Özellikler



	1500 WOC H DD	1600 ST DD	1600 WOC H DD	1600 WOC HD DD
<b>Dimensions / Boyutlar</b>				
Gross Volume (L) Brüt Hacim	1355	1371	1390	1634
Net Volume (L) Net Hacim	1161	1264	1350	1526
Internal Dimensions (w*d*h) (mm) / İç Ölçüler	1400*551*1682	1500*551*1582	1500*551*1682	1500*621*1682
External Dimensions (w*d*h) (mm) / Dış Ölçüler	1500*677*2121	1600*677*2040	1600*677*2164	1600*740*2164
External Dimensions with Package (w*d*h) (mm) / Ambalajlı Dış Ölçüler	1532*699*2261	1632*699*2180	1632*699*2304	1632*762*2304
<b>Packaging / Paketleme</b>				
Net Weight (kg) Net Ağırlık				
Gross Weight (kg) Brüt Ağırlık				
<b>Product Loading / Ürün Yükleme</b>				
Number of Products Loaded on the Width (330 ml - Ø 66,3 mm) Genişliğe Yüklenen Ürün Adedi	21	22	22	22
Number of Products Loaded on the Depth (330 ml - Ø 66,3 mm) Derinliğe Yüklenen Ürün Adedi	6	6	6	7
Number of Products Loaded on the Width (330 ml - Ø 57 mm) Genişliğe Yüklenen Ürün Adedi	24	25	25	25
Number of Products Loaded on the Depth (330 ml - Ø 57 mm) Derinliğe Yüklenen Ürün Adedi	7	7	7	9
Product Display Area (m <sup>2</sup> ) Ürünün Kapladığı Alan	1,005	1,072	1,072	1,184
Can Loading Unit (330 ml - Ø 66,3 mm) / Kutu Yükleme Adedi	1355	1452	1452	1694
Bottle Loading Unit (500 ml) Şişe Yükleme Adedi	739	660	792	924
<b>Technical Specifications / Teknik Özellikler</b>				
Number of Shelves Raf Sayısı	2*5	2*5	2*5	2*5
Insulation Thickness (mm) İzolasyon Kalınlığı	50	50	50	50
Working Temperature Range °C Çalışma Sıcaklık Aralığı	0/ 10 C°	0/ 10 C°	0/ 10 C°	0/ 10 C°
Refrigerant Soğutucu Gaz	R290a	R290a	R290a	R290a
Climate Class İklim Sınıfı	B/C	B/C	B/C	B/C
Supply Voltage Besleme Gerilimi	220-240 / 50 V/Hz	220-240 / 50 V/Hz	220-240 / 50 V/Hz	220-240 / 50 V/Hz
<b>Logistics / Lojistik</b>				
20" / 40" / 40H" Container Loading Unit / 20" / 40" / 40H" Konteyner Yükleme Adedi	11 / 24 / 24	11 / 24 / 24	11 / 24 / 24	11 / 24 / 24
13,6 m Truck Loading Unit 13,6 m Tır Yükleme Adedi	27	27	27	27

## Triple Door Vertical Coolers

Üç Kapılı Dikey Soğutucular

### Technical Specifications

Teknik Özellikler



	1500 WOC ST TD	1500 WOC H TD	1600 ST TD	1600 H TD	1600 HD TD
<b>Dimensions / Boyutlar</b>					
Gross Volume (L) Brüt Hacim	1280	1355	1371	1390	1634
Net Volume (L) Net Hacim	1162	1157	1253	1338	1514
Internal Dimensions (w*d*h) (mm) / İç Ölçüler	1400*551.2*1582	1400*551*1682	1500*551*1582	1500*551*1682	1500*621*1682
External Dimensions (w*d*h) (mm) / Dış Ölçüler	1500*677*2021	1500*677*2121	1600*677*2040	1600*677*2164	1600*740*2164
External Dimensions with Package (w*d*h) (mm) / Ambalajlı Dış Ölçüler	1532*699*2161	1532*699*2261	1632*699*2180	1632*699*2304	1632*762*2304
<b>Packaging / Paketleme</b>					
Net Weight (kg) Net Ağırlık					
Gross Weight (kg) Brüt Ağırlık					
<b>Product Loading / Ürün Yükleme</b>					
Number of Products Loaded on the Width (330 ml - Ø 66,3 mm) Genişliğe Yüklenen Ürün Adedi	21	21	22	22	22
Number of Products Loaded on the Depth (330 ml - Ø 66,3 mm) Derinliğe Yüklenen Ürün Adedi	6	6	6	6	7
Number of Products Loaded on the Width (330 ml - Ø 57 mm) Genişliğe Yüklenen Ürün Adedi	24	24	25	25	25
Number of Products Loaded on the Depth (330 ml - Ø 57 mm) Derinliğe Yüklenen Ürün Adedi	7	7	7	7	9
Product Display Area (m <sup>2</sup> ) Ürünün Kapladığı Alan	1,005	1,005	1,072	1,072	1,184
Can Loading Unit (330 ml - Ø 66,3 mm) / Kutu Yükleme Adedi	1355	1355	1452	1452	1694
Bottle Loading Unit (500 ml) Şişe Yükleme Adedi	616	739	660	792	924
<b>Technical Specifications / Teknik Özellikler</b>					
Number of Shelves Raf Sayısı	3*5	3*5	3*5	3*5	3*5
Insulation Thickness (mm) İzolasyon Kalınlığı	50	50	50	50	50
Working Temperature Range °C Çalışma Sıcaklık Aralığı	0/ 10 C°	0/ 10 C°	0/ 10 C°	0/ 10 C°	0/ 10 C°
Refrigerant Soğutucu Gaz	R290a	R290a	R290a	R290a	R290a
Climate Class İklim Sınıfı	B/C	B/C	B/C	B/C	B/C
Supply Voltage Besleme Gerilimi	220-240 / 50 V/Hz	220-240 / 50 V/Hz	220-240 / 50 V/Hz	220-240 / 50 V/Hz	220-240 / 50 V/Hz
<b>Logistics / Lojistik</b>					
20" / 40" / 40H" Container Loading Unit / 20" / 40" / 40H" Konteyner Yükleme Adedi	11 / 24 / 24	11 / 24 / 24	11 / 24 / 24	11 / 24 / 24	11 / 24 / 24
13,6 m Truck Loading Unit 13,6 m Tır Yükleme Adedi	27	27	27	27	27

## Single Door Vertical Freezers

Tek Kapılı Dikey Dondurucular

### Technical Specifications

Teknik Özellikler



	180 C VF	377 C VF	390 C VF	390 WOC VF	
Dimensions / Boyutlar	Gross Volume (L) Brüt Hacim	195	378	365	
	Net Volume (L) Net Hacim	170	365	355	
	Internal Dimensions (w*d*h) (mm) / İç Ölçüler	357*366*1410	516*470*1555	490*463.5*1458.5	490*463.5*1458.5
Packaging / Paketleme	External Dimensions (w*d*h) (mm) / Dış Ölçüler	435*516,5*2008,5	640*630*1875,5	590*642*2005	590*621*1844
	External Dimensions with Package (w*d*h) (mm) / Ambalajlı Dış Ölçüler	464*574*2138,5	655*645*2000	605*664*2145	605*646*1984
	Net Weight (kg) Net Ağırlık	70	82	102	100
Product Loading / Ürün Yükleme	Gross Weight (kg) Brüt Ağırlık	76	90	108.5	110
	Number of Products Loaded on the Width (330 ml - Ø 66,3 mm) Genişliğe Yüklene Ürün Adedi	NA	NA	NA	NA
	Number of Products Loaded on the Depth (330 ml - Ø 66,3 mm) Derinliğe Yüklene Ürün Adedi	NA	NA	NA	NA
Technical Specifications / Teknik Özellikler	Number of Products Loaded on the Width (330 ml - Ø 57 mm) Genişliğe Yüklene Ürün Adedi	NA	NA	NA	NA
	Number of Products Loaded on the Depth (330 ml - Ø 57 mm) Derinliğe Yüklene Ürün Adedi	NA	NA	NA	NA
	Product Display Area (m <sup>2</sup> ) Ürünün Kapladığı Alan	0,22	0,403	0,357	0,357
Logistics / Lojistik	Can Loading Unit (330 ml - Ø 66,3 mm) / Kutu Yükleme Adedi	NA	NA	NA	NA
	Bottle Loading Unit (500 ml) Şişe Yükleme Adedi	NA	NA	NA	NA
	Number of Shelves Raf Sayısı	6	6	5	5
Logistics / Lojistik	Insulation Thickness (mm) İzolasyon Kalınlığı	40	60	50	50
	Working Temperature Range °C Çalışma Sıcaklık Aralığı	-18 / -24 °C	-18 / -24 °C	-18 / -24 °C	-18 / -24 °C
	Refrigerant Soğutucu Gaz	R290a	R290a	R290a	R290a
Logistics / Lojistik	Climate Class İklim Sınıfı	B/C	B/C	B/C	B/C
	Supply Voltage Besleme Gerilimi	220-240 / 50 V/Hz	220-240 / 50 V/Hz	220-240 / 50 V/Hz	220-240 / 50 V/Hz
	20" / 40" / 40H" Container Loading Unit / 20" / 40" / 40H" Konteyner Yükleme Adedi	48 / 100 / 100	27 / 54 / 54	26 / 57 / 57	26 / 57 / 57
Logistics / Lojistik	13,6 m Truck Loading Unit 13,6 m Tır Yükleme Adedi	120	63	84	84

## Mini Coolers

Mini Soğutucular

### Technical Specifications

Teknik Özellikler



	MC 60 WOC	MC 85 WOC	BB 100 WOC	BB 110 WOC	BB 170 WOC	
Dimensions / Boyutlar	Gross Volume (L) Brüt Hacim	70	90	82	109	142
	Net Volume (L) Net Hacim	64	89	79	101	138
	Internal Dimensions (w*d*h) (mm) / İç Ölçüler	354*346,5*531	355*323*740	281*409,5*686	355*409,5*686	490*447,5*670,5
Packaging / Paketleme	External Dimensions (w*d*h) (mm) / Dış Ölçüler	451*579*667	438,5*512*832	361*621*855	455*621*855	590*618,5*866
	External Dimensions with Package (w*d*h) (mm) / Ambalajlı Dış Ölçüler	483*610*731,5	470,5*535*890	381*670*1000	475*670*1000	630*658,5*960
	Net Weight (kg) Net Ağırlık	31	35	39	45	63
Product Loading / Ürün Yükleme	Gross Weight (kg) Brüt Ağırlık	36	39	45	69	69
	Number of Products Loaded on the Width (330 ml - Ø 66,3 mm) Genişliğe Yüklene Ürün Adedi	5	5	4	5	7
	Number of Products Loaded on the Depth (330 ml - Ø 66,3 mm) Derinliğe Yüklene Ürün Adedi	5	4	5	6	6
Technical Specifications / Teknik Özellikler	Number of Products Loaded on the Width (330 ml - Ø 57 mm) Genişliğe Yüklene Ürün Adedi	5	6	4	6	8
	Number of Products Loaded on the Depth (330 ml - Ø 57 mm) Derinliğe Yüklene Ürün Adedi	5	5	6	7	7
	Product Display Area (m <sup>2</sup> ) Ürünün Kapladığı Alan	0,26	0,211	0,218	0,278	0,365
Logistics / Lojistik	Can Loading Unit (330 ml - Ø 66,3 mm) / Kutu Yükleme Adedi	70	85	88	120	182
	Bottle Loading Unit (500 ml) Şişe Yükleme Adedi	39	40	36	50	70
	Number of Shelves Raf Sayısı	1	2	2	2	2
Logistics / Lojistik	Insulation Thickness (mm) İzolasyon Kalınlığı	50	38	38	50	50
	Working Temperature Range °C Çalışma Sıcaklık Aralığı	0 / +10 °C	0 / +10 °C	0 / +10 °C	0 / +10 °C	0 / +10 °C
	Refrigerant Soğutucu Gaz	R600a	R600a	R600a	R600a	R600a
Logistics / Lojistik	Climate Class İklim Sınıfı	B/C	B/C	B/C	B/C	B/C
	Supply Voltage Besleme Gerilimi	220-240 / 50 V/Hz	220-240 / 50 V/Hz	220-240 / 50 V/Hz	220-240 / 50 V/Hz	220-240 / 50 V/Hz
	20" / 40" / 40H" Container Loading Unit / 20" / 40" / 40H" Konteyner Yükleme Adedi	135 / 273 / 273	96 / 200 / 300	102 / 210 / 210	72 / 150 / 150	54 / 114 / 114
Logistics / Lojistik	13,6 m Truck Loading Unit 13,6 m Tır Yükleme Adedi	336	375	250	200	132

## Under Bar Coolers

Bar Altı Soğutucular

### Technical Specifications

Teknik Özellikler



	MC 88 WOC	BB 230 WOC	BB 240 WOC	BB 230 Sliding	BB 240 Sliding	
Dimensions / Boyutlar	Gross Volume (L) Brüt Hacim	87	195	298	164	260
	Net Volume (L) Net Hacim	83	175	271	145	234
	Internal Dimensions (w*d*h) (mm) / İç Ölçüler	740*301*355	806*373*670.5	1263.5*378*670.5	806*354*670.5	1263.5*345*670.5
Packaging / Paketleme	External Dimensions (w*d*h) (mm) / Dış Ölçüler	810*510*450	907*540*866	1364*540*866	907*480*866	1364*480*866
	External Dimensions with Package (w*d*h) (mm) / Ambalajlı Dış Ölçüler	842*532*519	945*580*960	1405*580*960	945*520*960	1405*520*960
	Net Weight (kg) Net Ağırlık	35	77,25	78	77,25	78
Product Loading / Ürün Yükleme	Gross Weight (kg) Brüt Ağırlık	39	82,5	83	82,5	83
	Number of Products Loaded on the Width (330 ml - Ø 66,3 mm) Genişliğe Yüklenen Ürün Adedi	10	12	18	12	18
	Number of Products Loaded on the Depth (330 ml - Ø 66,3 mm) Derinliğe Yüklenen Ürün Adedi	4	4	5	4	5
Technical Specifications / Teknik Özellikler	Number of Products Loaded on the Width (330 ml - Ø 57 mm) Genişliğe Yüklenen Ürün Adedi	12	13	21	13	21
	Number of Products Loaded on the Depth (330 ml - Ø 57 mm) Derinliğe Yüklenen Ürün Adedi	6	5	5	5	5
	Product Display Area (m²) Ürünün Kapladığı Alan	0,41	0,48	0,74	0,48	0,74
Logistics / Lojistik	Can Loading Unit (330 ml - Ø 66,3 mm) / Kutu Yükleme Adedi	68	192	338	192	338
	Bottle Loading Unit (500 ml) Şişe Yükleme Adedi	34	72	147	72	147
	Number of Shelves Raf Sayısı	2	2	3*2	2	3*2
Logistics / Lojistik	Insulation Thickness (mm) İzolasyon Kalınlığı	38	50	50	50	50
	Working Temperature Range °C Çalışma Sıcaklık Aralığı	0 / +10 °C	0 / +10 °C	0 / +10 °C	0 / +10 °C	0 / +10 °C
	Refrigerant Soğutucu Gaz	R600a	R600a	R600a	R600a	R600a
Logistics / Lojistik	Climate Class İklim Sınıfı	B/C	B/C	B/C	B/C	B/C
	Supply Voltage Besleme Gerilimi	220-240 / 50 V/Hz	220-240 / 50 V/Hz	220-240 / 50 V/Hz	220-240 / 50 V/Hz	220-240 / 50 V/Hz
	20" / 40" / 40H" Container Loading Unit / 20" / 40" / 40H" Konteyner Yükleme Adedi	112 / 232 / 290	48 / 100 / 100	32 / 66 / 66	48 / 100 / 100	32 / 66 / 66
Logistics / Lojistik	13,6 m Truck Loading Unit 13,6 m Tır Yükleme Adedi	330	112	74	112	88

## Can Cooler

Can Cooler

### Technical Specifications

Teknik Özellikler



	50 R	70 R	
Dimensions / Boyutlar	Gross Volume (L) Brüt Hacim	46	61
	Net Volume (L) Net Hacim	45	60
	Internal Dimensions (w*d*h) (mm) / İç Ölçüler	Ø378*410	Ø378*517
Packaging / Paketleme	External Dimensions (w*d*h) (mm) / Dış Ölçüler	Ø454*825	Ø454*932
	External Dimensions with Package (w*d*h) (mm) / Ambalajlı Dış Ölçüler	900*550*550	1007*550*550
	Net Weight (kg) Net Ağırlık	26	33
Product Loading / Ürün Yükleme	Gross Weight (kg) Brüt Ağırlık	29	36
	Number of Products Loaded on the Width (330 ml - Ø 66,3 mm) Genişliğe Yüklenen Ürün Adedi	NA	NA
	Number of Products Loaded on the Depth (330 ml - Ø 66,3 mm) Derinliğe Yüklenen Ürün Adedi	NA	NA
Technical Specifications / Teknik Özellikler	Number of Products Loaded on the Width (330 ml - Ø 57 mm) Genişliğe Yüklenen Ürün Adedi	NA	NA
	Number of Products Loaded on the Depth (330 ml - Ø 57 mm) Derinliğe Yüklenen Ürün Adedi	NA	NA
	Product Display Area (m²) Ürünün Kapladığı Alan	NA	NA
Logistics / Lojistik	Can Loading Unit (330 ml - Ø 66,3 mm) / Kutu Yükleme Adedi	NA	NA
	Bottle Loading Unit (500 ml) Şişe Yükleme Adedi	NA	NA
	Number of Shelves Raf Sayısı	NA	NA
Logistics / Lojistik	Insulation Thickness (mm) İzolasyon Kalınlığı	40	40
	Working Temperature Range °C Çalışma Sıcaklık Aralığı	0 / +10 °C	0 / +10 °C
	Refrigerant Soğutucu Gaz	R600a	R600a
Logistics / Lojistik	Climate Class İklim Sınıfı	B/C	B/C
	Supply Voltage Besleme Gerilimi	220-240 / 50 V/Hz	220-240 / 50 V/Hz
	20" / 40" / 40H" Container Loading Unit / 20" / 40" / 40H" Konteyner Yükleme Adedi	104 / 220 / 220	80 / 212 / 212
Logistics / Lojistik	13,6 m Truck Loading Unit 13,6 m Tır Yükleme Adedi	315	260

## Counter Front Coolers

Kasa Önü Soğutucular

### Technical Specifications

Teknik Özellikler



**HT 200**



**HT 300**



**HT 400**

Dimensions / Boyutlar	HT 200			HT 300			HT 400						
	Gross Volume (L) Brüt Hacim	210	300	387	Net Volume (L) Net Hacim	158	222	288	Internal Dimensions (w*d*h) (mm) / İç Ölçüler	720*720*408	1020*720*408	1320*720*408	
External Dimensions (w*d*h) (mm) / Dış Ölçüler	External Dimensions (w*d*h) (mm) / Dış Ölçüler	750*750*981	1050*750*981	1350*750*981	External Dimensions with Package (w*d*h) (mm) / Ambalajlı Dış Ölçüler	779*779*1008	1079*779*1008	1379*779*1008	Packaging / Paketleme	Net Weight (kg) Net Ağırlık	-	-	-
	Gross Weight (kg) Brüt Ağırlık	-	-	-	Product Loading / Ürün Yükleme	Number of Products Loaded on the Width (330 ml - Ø 66,3 mm) Genişliğe Yüklenen Ürün Adedi	9	13		18	Number of Products Loaded on the Depth (330 ml - Ø 66,3 mm) Derinliğe Yüklenen Ürün Adedi	8	8
Product Loading / Ürün Yükleme	Number of Products Loaded on the Width (330 ml - Ø 57 mm) Genişliğe Yüklenen Ürün Adedi	9	9	9		Number of Products Loaded on the Depth (330 ml - Ø 57 mm) Derinliğe Yüklenen Ürün Adedi	10	16	21	Technical Specifications / Teknik Özellikler	Product Display Area (m <sup>2</sup> ) Ürünün Kapladığı Alan	0,562	0,787
	Can Loading Unit (330 ml - Ø 66,3 mm) / Kutu Yükleme Adedi	144	208	378	Bottle Loading Unit (500 ml) Şişe Yükleme Adedi	63	91	119	Number of Shelves Raf Sayısı		-	-	-
Technical Specifications / Teknik Özellikler	Insulation Thickness (mm) İzolasyon Kalınlığı	56-61	56-61	56-61	Working Temperature Range °C Çalışma Sıcaklık Aralığı	+3°C / +5°C	+3°C / +5°C	+3°C / +5°C	Logistics / Lojistik	Refrigerant Soğutucu Gaz	R290	R290	R290
	Climate Class İklim Sınıfı	B/C (R134a/R600a)	B/C (R134a/R600a)	B/C (R134a/R600a)	Supply Voltage Besleme Gerilimi	220-240 / 50 V/Hz	220-240 / 50 V/Hz	220-240 / 50 V/Hz		20" / 40" / 40H" Container Loading Unit / 20" / 40" / 40H" Konteyner Yükleme Adedi	21 / 45 / 45	15 / 33 / 33	12 / 25 / 25
Logistics / Lojistik	13,6 m Truck Loading Unit 13,6 m Tır Yükleme Adedi	51	36	27									

## Wine Coolers

Şarap Soğutucuları

### Technical Specifications

Teknik Özellikler



**170 WOC WINE**



**230 WOC WINE**



**180 EWOC WINE**



**270 C WINE**

Dimensions / Boyutlar	170 WOC WINE				230 WOC WINE				180 EWOC WINE				270 C WINE			
	Gross Volume (L) Brüt Hacim	134	183	195	238	Net Volume (L) Net Hacim	125	163	170	226	Internal Dimensions (w*d*h) (mm) / İç Ölçüler	490*466*670	806*399*670	357*363*1410	355*465,5*1442	
External Dimensions (w*d*h) (mm) / Dış Ölçüler	External Dimensions (w*d*h) (mm) / Dış Ölçüler	591*666,5*853	906*554*853	435*554*1862,5	455*623*2031	External Dimensions with Package (w*d*h) (mm) / Ambalajlı Dış Ölçüler	611*690*940	926*574*950	450*587*1983,5	493*663*2125	Packaging / Paketleme	Net Weight (kg) Net Ağırlık	0,192	0,192	0,192	0,192
	Gross Weight (kg) Brüt Ağırlık	56	77,25	73	90	Product Loading / Ürün Yükleme	Product Display Area (m <sup>2</sup> ) Ürünün Kapladığı Alan	62	82,5	79		98	Wine Bottle Loading Unit (500 ml) Şarap Şişesi Yükleme Adedi	21	31	56
Product Loading / Ürün Yükleme	Number of Shelves Raf Sayısı	3+2	3+2	5	5		Insulation Thickness (mm) İzolasyon Kalınlığı	50	50	50	50	Technical Specifications / Teknik Özellikler	Working Temperature Range °C Çalışma Sıcaklık Aralığı	+5 / +18 °C	+5 / +18 °C	+5 / +18 °C
	Refrigerant Soğutucu Gaz	R600a	R600a	R600a	R600a	Climate Class İklim Sınıfı	B/C	B/C	B/C	B/C	Supply Voltage Besleme Gerilimi		220-240 / 50 V/Hz	220-240 / 50 V/Hz	220-240 / 50 V/Hz	220-240 / 50 V/Hz
Logistics / Lojistik	20" / 40" / 40H" Container Loading Unit / 20" / 40" / 40H" Konteyner Yükleme Adedi	54 / 114 / 114	48 / 100 / 100	52 / 104 / 104	40 / 85 / 85	13,6 m Truck Loading Unit 13,6 m Tır Yükleme Adedi	152	120	120	95						



## Wine Coolers

Şarap Soğutucuları

### Technical Specifications

Teknik Özellikler



	270 WOC WINE	375 C WINE	375 WOC WINE	380 C WINE	380 WOC WINE
<b>Dimensions / Boyutlar</b>					
Gross Volume (L) Brüt Hacim	238	378	378	378	378
Net Volume (L) Net Hacim	226	365	365	365	365
Internal Dimensions (w*d*h) (mm) / İç Ölçüler	355*465,5*1442	516*470*1555	516*470*1555	490*444*1555	490*465*1555
External Dimensions (w*d*h) (mm) / Dış Ölçüler	455*623*1853,5	590*628*1827	590*628*1827	590*621*2005	590*663*1885
External Dimensions with Package (w*d*h) (mm) / Ambalajlı Dış Ölçüler	493*663*1947,5	605*653*1943	605*653*1943	605*646*2141	605*697*2009
<b>Packaging / Paketleme</b>					
Net Weight (kg) Net Ağırlık	0,192	0,192	0,192	0,192	0,192
Gross Weight (kg) Brüt Ağırlık	90	75	75	100	96
<b>Technical Specifications / Teknik Özellikler</b>					
Product Display Area (m²) Ürünün Kapladığı Alan	98	82	82	106	101,5
Wine Bottle Loading Unit (500 ml) Şarap Şişesi Yükleme Adedi	63	75	75	81	81
Number of Shelves Raf Sayısı	5	5	5	5	5
Insulation Thickness (mm) İzolasyon Kalınlığı	50	50	50	50	50
Working Temperature Range °C Çalışma Sıcaklık Aralığı	+5 / +18 °C	+5 / +18 °C	+5 / +18 °C	+5 / +18 °C	+5 / +18 °C
Refrigerant Soğutucu Gaz	R600a	R600a	R600a	R600a	R600a
Climate Class İklim Sınıfı	B/C	B/C	B/C	B/C	B/C
Supply Voltage Besleme Gerilimi	220-240 / 50 V/Hz	220-240 / 50 V/Hz	220-240 / 50 V/Hz	220-240 / 50 V/Hz	220-240 / 50 V/Hz
<b>Logistics / Lojistik</b>					
20" / 40" / 40H" Container Loading Unit / 20" / 40" / 40H" Konteyner Yükleme Adedi	36 / 72 / 72	27 / 57 / 57	26 / 55 / 55	27 / 57 / 57	26 / 55 / 55
13,6 m Truck Loading Unit 13,6 m Tır Yükleme Adedi	95	76	80	84	80

## 360 Modular Coolers

360 Modüler Soğutucular

### Technical Specifications

Teknik Özellikler



	360 D	360 DSS	360 DSS-90-SA
<b>Dimensions / Boyutlar</b>			
Gross Volume (L) Brüt Hacim	140	190	260
Net Volume (L) Net Hacim	115	165	200
Internal Dimensions (w*d*h) (mm) / İç Ölçüler	583*335*996	583*336*1376	587*389*1376
External Dimensions (w*d*h) (mm) / Dış Ölçüler	698*495*1446	698*495*1826	698*495*1810
External Dimensions with Package (w*d*h) (mm) / Ambalajlı Dış Ölçüler	735*550*1575	735*550*1955	735*550*2250
<b>Packaging / Paketleme</b>			
Net Weight (kg) Net Ağırlık	75	88	91
Gross Weight (kg) Brüt Ağırlık	81	93	98
<b>Product Loading / Ürün Yükleme</b>			
Number of Products Loaded on the Width (330 ml - Ø 66,3 mm) Genişliğe Yüklenebilir Ürün Adedi	7	7	8
Number of Products Loaded on the Depth (330 ml - Ø 66,3 mm) Derinliğe Yüklenebilir Ürün Adedi	4	4	4
Number of Products Loaded on the Width (330 ml - Ø 57 mm) Genişliğe Yüklenebilir Ürün Adedi	9	9	10
Number of Products Loaded on the Depth (330 ml - Ø 57 mm) Derinliğe Yüklenebilir Ürün Adedi	5	5	5
Product Display Area (m²) Ürünün Kapladığı Alan	0,21	0,21	0,218
Can Loading Unit (330 ml - Ø 66,3 mm) / Kutu Yükleme Adedi	200	225	-
Bottle Loading Unit (500 ml) Şişe Yükleme Adedi	100	125	-
<b>Technical Specifications / Teknik Özellikler</b>			
Number of Shelves Raf Sayısı	3	4	4
Insulation Thickness (mm) İzolasyon Kalınlığı	40	40	40
Working Temperature Range °C Çalışma Sıcaklık Aralığı	0 / +10 °C	0 / +10 °C	0 / +10 °C
Refrigerant Soğutucu Gaz	R600a	R600a	R600a
Climate Class İklim Sınıfı	B/C	B/C	B/C
Supply Voltage Besleme Gerilimi	220-240 / 50 V/Hz	220-240 / 50 V/Hz	220-240 / 50 V/Hz
<b>Logistics / Lojistik</b>			
20" / 40" / 40H" Container Loading Unit / 20" / 40" / 40H" Konteyner Yükleme Adedi	32 / 64 / 64	32 / 64 / 64	32 / 64 / 64
13,6 m Truck Loading Unit 13,6 m Tır Yükleme Adedi	72	72	72

## Pallet Modular Coolers

Palet Modüller  
Soğutucular

### Technical Specifications

Teknik Özellikler



**500 P**



**1000 P**

Dimensions / Boyutlar	500 P	1000 P
Gross Volume (L) Brüt Hacim	843	1188
Net Volume (L) Net Hacim	752	1093
Internal Dimensions (w*d*h) (mm) / İç Ölçüler	900*665*1373	900*668*1800
External Dimensions (w*d*h) (mm) / Dış Ölçüler	1000*830*1770	1000*851.5*2195
External Dimensions with Package (w*d*h) (mm) / Ambalajlı Dış Ölçüler	1040*855*1915	1015*876.5*2332
Net Weight (kg) Net Ağırlık	132.5	208
Gross Weight (kg) Brüt Ağırlık	138.5	222
Number of Products Loaded on the Width (330 ml - Ø 66,3 mm) Genişliğe Yüklenen Ürün Adedi	13	13
Number of Products Loaded on the Depth (330 ml - Ø 66,3 mm) Derinliğe Yüklenen Ürün Adedi	10	9
Number of Products Loaded on the Width (330 ml - Ø 57 mm) Genişliğe Yüklenen Ürün Adedi	15	15
Number of Products Loaded on the Depth (330 ml - Ø 57 mm) Derinliğe Yüklenen Ürün Adedi	11	10
Product Display Area (m²) Ürünün Kapladığı Alan	0,83	0,852
Can Loading Unit (330 ml - Ø 66,3 mm) / Kutu Yükleme Adedi	1300	345+1 pallet (768)
Bottle Loading Unit (500 ml) Şişe Yükleme Adedi	650	116+1 pallet (432)
Number of Shelves Raf Sayısı	0	1
Insulation Thickness (mm) İzolasyon Kalınlığı	50	50
Working Temperature Range °C Çalışma Sıcaklık Aralığı	4 / +12 °C	4 / +12 °C
Refrigerant Soğutucu Gaz	R290a	R290a
Climate Class İklim Sınıfı	B/C	B/C
Supply Voltage Besleme Gerilimi	220-240 / 50 V/Hz	220-240 / 50 V/Hz
20" / 40" / 40H" Container Loading Unit / 20" / 40" / 40H" Konteyner Yükleme Adedi	12 / 28 / 28	12 / 26 / 26
13,6 m Truck Loading Unit 13,6 m Tır Yükleme Adedi	30	30





WINE SERIES  
Şarap Soğutucular

RESERVE



14



Dimensions / Ölçüler  
(w\*d\*h) 361\*646\*864,5



20



Dimensions / Ölçüler  
(w\*d\*h) 591\*688\*853



20 DUAL



Dimensions / Ölçüler  
(w\*d\*h) 591\*688\*853

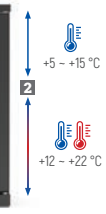

30



Dimensions / Ölçüler  
(w\*d\*h) 906\*576\*853



104



Dimensions / Ölçüler  
(w\*d\*h) 590\*685\*1885



104 DUAL



Dimensions / Ölçüler  
(w\*d\*h) 590\*685\*1885

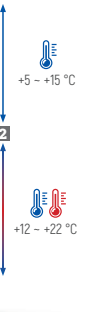

14



Dimensions / Ölçüler  
(w\*d\*h) 361\*646\*864,5



20



Dimensions / Ölçüler  
(w\*d\*h) 591\*688\*853



20 DUAL



Dimensions / Ölçüler  
(w\*d\*h) 591\*688\*853

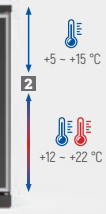

30



Dimensions / Ölçüler  
(w\*d\*h) 906\*576\*853



104



Dimensions / Ölçüler  
(w\*d\*h) 590\*685\*1885



104 DUAL



Dimensions / Ölçüler  
(w\*d\*h) 590\*685\*1885

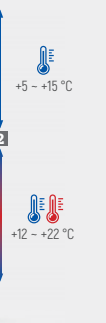

ELEGANZA

RACCOLTO

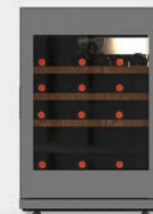

20 S



Dimensions / Ölçüler  
(w\*d\*h) 591\*688\*853

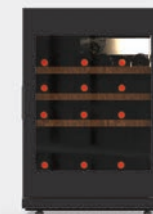

20 B



Dimensions / Ölçüler  
(w\*d\*h) 591\*688\*853



90 S

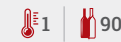

Dimensions / Ölçüler  
(w\*d\*h) 590\*620\*2057



90 B



Dimensions / Ölçüler  
(w\*d\*h) 590\*620\*2057

MASTER



20



Dimensions / Ölçüler  
(w\*d\*h) 592\*624\*865,5



90



Dimensions / Ölçüler  
(w\*d\*h) 590\*620\*2057

BACCHUS



20



Dimensions / Ölçüler  
(w\*d\*h) 592\*624\*865,5



90



Dimensions / Ölçüler  
(w\*d\*h) 590\*620\*2057

AMARONE



V45



Dimensions / Ölçüler  
(w\*d\*h) 596\*556\*463



V60



Dimensions / Ölçüler  
(w\*d\*h) 596\*556\*607

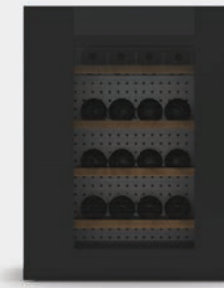

V72



Dimensions / Ölçüler  
(w\*d\*h) 596\*556\*730

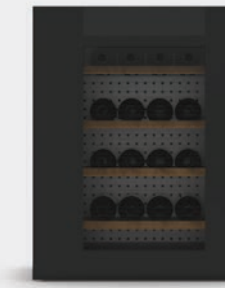

V80



Dimensions / Ölçüler  
(w\*d\*h) 596\*556\*875,5



CUSTOM MADE



# AMARONE SERIES

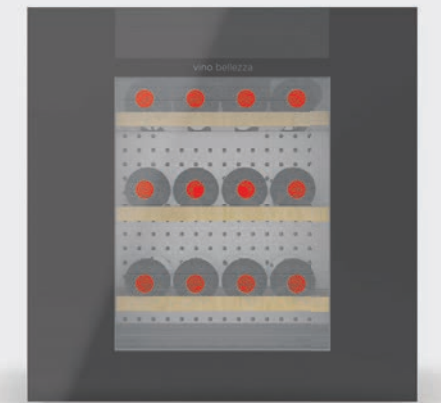
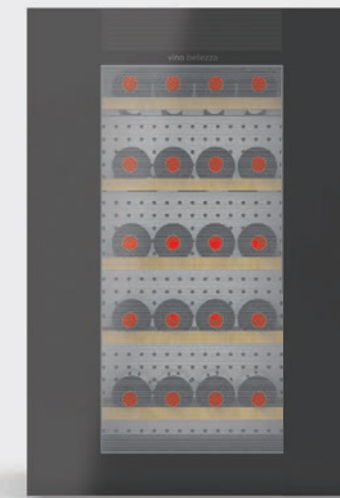
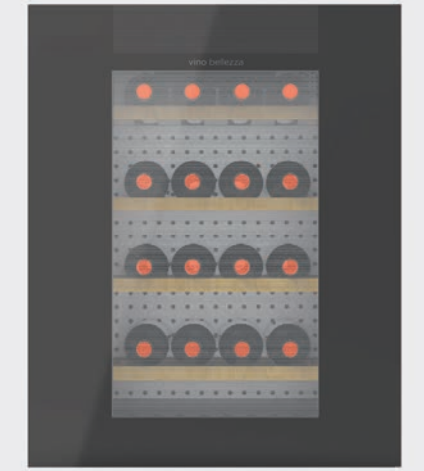
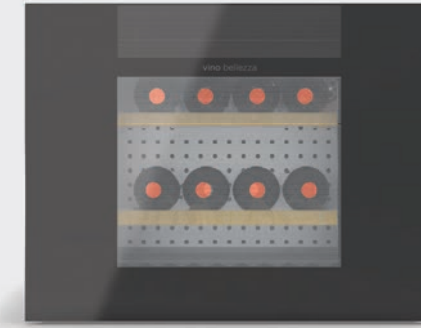

# AMARONE

## Technical Specifications

### Teknik Özellikler



V45

V60

V72

V80

Gross Volume (Lt.) Brüt Hacim (Lt.)	154	201	242	290
Net Volume (Lt.) Net Hacim (Lt.)	60	82	104	128
Internal Dimensions (w*d*h) (mm) İç ölçüler (w*d*h) (mm)	492*330*369	492*330*509	492*330*643	492*330*789
External Dimensions (w*d*h) (mm) Dış Ölçüler (w*d*h) (mm)	596*556*463	596*556*607	596*556*730	596*556*875.5
Packaged Dimensions (w*d*h) (mm) Ambalajlı Dış Ölçüler (w*d*h) (mm)	690*750*734	690*750*877	690*750*1010	690*750*1157
Footprint (m <sup>2</sup> ) Ürünün kapladığı alan (m <sup>2</sup> )	0.331	0.331	0.331	0.331
Wine Bottle Capacity Şarap Yükleme Adedi	21	26	31	36
20" Container Loading Capacity 20" Konteyner Yükleme Adedi	72	54	51	48
40" Container Loading Capacity 40" Konteyner Yükleme Adedi	153	117	105	102
40" High Container Loading Capacity 40" Yüksek Konteyner Yükleme Adedi	153	153	105	102
13,6 Meter Truck Loading Capacity 13,6 Metre Tır Yükleme Adedi	171	171	117	114
Temperature Range Çalışma Sıcaklık Aralığı °C	+5 / +18 °C	+5 / +18 °C	+5 / +18 °C	+5 / +18 °C
Climate Class Soğutucu Gaz	R600a	R600a	R600a	R600a
Energy Class İklim Sınıfı	B	B	B	B
Supply Voltage Besleme Gerilimi	220-240V /50Hz	220-240V /50Hz	220-240V /50Hz	220-240V /50Hz
LED Lighting Led Aydınlatma	Yes Evet	Yes Evet	Yes Evet	Yes Evet
4 Wheels 4 Tekerlek	No Hayır	No Hayır	No Hayır	No Hayır
2 Adjustable Feet 2 Ayarlanabilir Ayak	4 Adjustable Feet 4 Ayarlanabilir Ayak	4 Adjustable Feet 4 Ayarlanabilir Ayak	4 Adjustable Feet 4 Ayarlanabilir Ayak	4 Adjustable Feet 4 Ayarlanabilir Ayak
Door Type Kapı Tipi	Frameless	Frameless	Frameless	Frameless

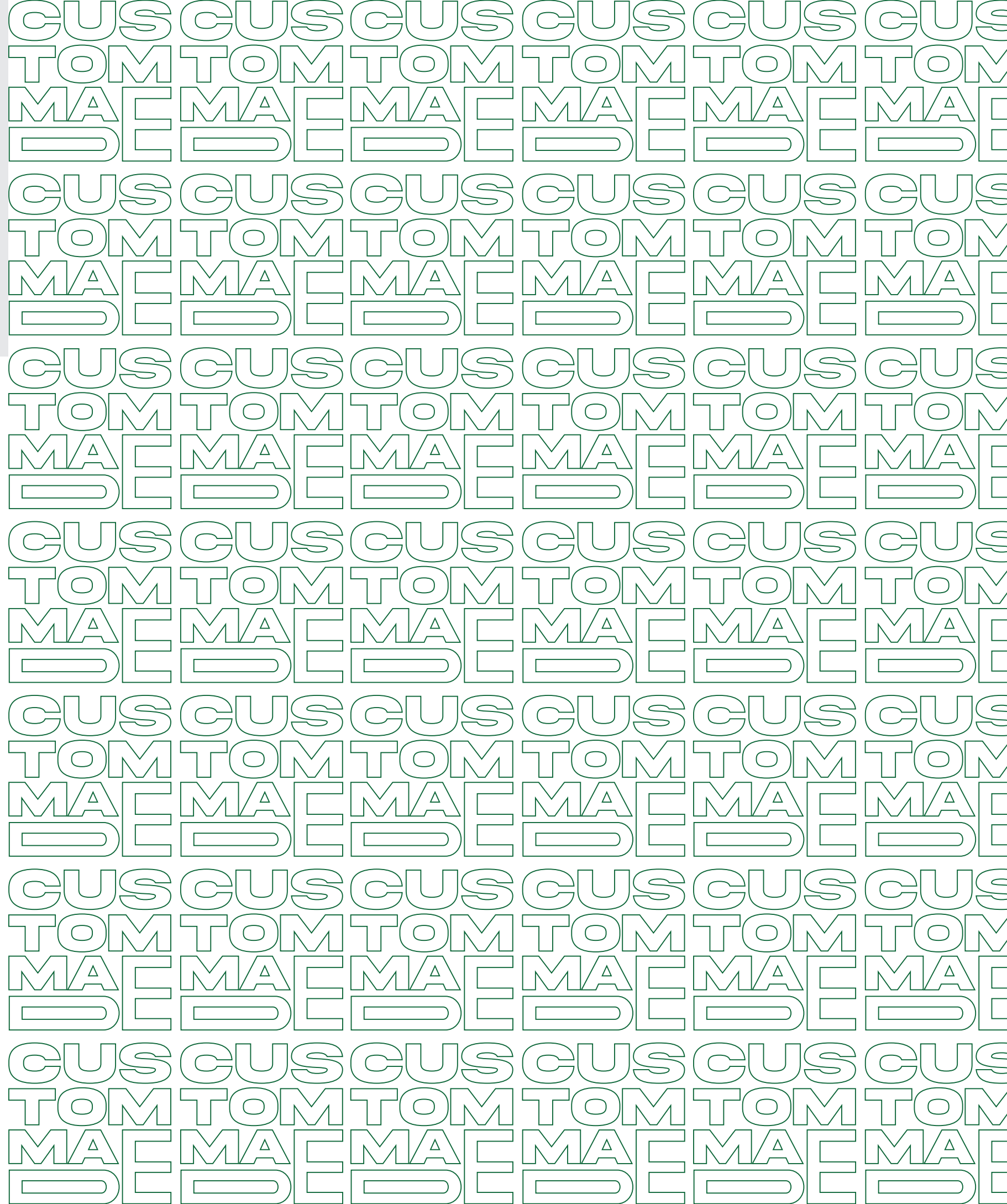

**FACTORY**

**T** +90 236 213 12 12 (pbx)

**F** +90 236 213 12 08

M.O.S.B 4. Kısım Ahmet  
Nazif Zorlu Bulvarı No:32  
Manisa/TÜRKİYE

**ISTANBUL OFFICE**

**T** +90 212 272 15 95

Metrocity AVM  
Büyükdere Caddesi  
No:171 - BB107 Şişli,  
Istanbul/TÜRKİYE

[www.greencooler.com.tr](http://www.greencooler.com.tr)

[info@greencooler.com.tr](mailto:info@greencooler.com.tr)

[@](#) [f](#) [in](#) greencooler